



APLUS[®]

Automotive Parts

AIR TANKS

www.aplus-automotive.com

BY APLUS NO / APLUS NUMARASINA GÖRE

INDEX

APLUS N	Page	APLUS No	Page	APLUS No	Page	APLUS No	Page	APLUS No	Page	APLUS No	Page
99114AP	76	99164AP	31	99209AP	36	99248AP	42	99290AP	27	99324AP	109
99116AP	28	99167AP	4-16-32-56-59-80	99210AP	13-83	99249AP	8-86	99291AP	56-75	99325AP	109
99117AP	28	99168AP	67-80	99211AP	84	99250AP	9-24-61-74-86	99292AP	75	99326AP	110
99118AP	29	99170AP	21	99212AP	7-23-37-49	99254AP	42	99293AP	12-27-89	99327AP	110
99119AP	57	99171AP	32	99213AP	37	99255AP	74	99296AP	65	99334AP	111
99121AP	19-76	99173AP	33	99215AP	84	99258AP	9-14-43-87	99297AP	19	99335AP	111
99122AP	1	99175AP	68	99216AP	38	99259AP	43-87	99298AP	13-17-65-90	99336AP	112
99123AP	77	99176AP	5	99217AP	38	99260AP	44	99299AP	14-63-90	99337AP	112
99124AP	2-15-18-77	99177AP	48-68	99218AP	49	99261AP	10	99302AP	99	99341AP	63
99125AP	2	99178AP	69	99219AP	50	99265AP	54	99303AP	100	99342AP	113
99127AP	3	99179AP	60-81	99220AP	50	99266AP	10	99304AP	100	99346AP	93
99128AP	57	99180AP	21-33-81	99221AP	51	99267AP	11	99305AP	101	99347AP	44-91
99129AP	78	99181AP	34	99222AP	70	99268AP	11	99306AP	101	99348AP	113
99132AP	46	99182AP	22	99223AP	71	99269AP	12	99307AP	102	99349AP	93
99135AP	58-78	99185AP	82	99225AP	39	99270AP	88	99308AP	102	99350AP	94
99137AP	66	99186AP	34	99227AP	51-85	99271AP	88	99310AP	103	99358AP	94
99139AP	20	99189AP	5	99229AP	39	99272AP	54	99311AP	103	99359AP	95
99143AP	79	99190AP	22	99231AP	52-71	99273AP	24	99312AP	104	99360AP	95
99145AP	29	99191AP	48-69	99233AP	40	99275AP	25	99313AP	104	99362AP	114
99146AP	30	99195AP	35	99234AP	72	99276AP	62	99314AP	105	99363AP	96
99150AP	30	99196AP	16-99	99235AP	52-72	99277AP	25	99315AP	105	99364AP	96
99151AP	3-31-79	99197AP	6	99236AP	61-85	99278AP	26	99316AP	106	99365AP	97
99153AP	58	99199AP	6	99237AP	73	99279AP	62	99317AP	106	99366AP	97
99154AP	47-66	99200AP	60-82	99238AP	8	99280AP	26	99318AP	107	99367AP	98
99156AP	59	99201AP	1-7-35-45-83	99240AP	40	99284AP	64-89	99319AP	92	99368AP	98
99157AP	15	99203AP	36	99242AP	41	99285AP	18	99320AP	92	99370AP	114
99160AP	47-67	99204AP	17	99243AP	41	99286AP	64	99321AP	107	99381AP	45
99161AP	4	99206AP	70	99244AP	53-73	99287AP	55	99322AP	108		
99162AP	20	99208AP	23	99247AP	53	99288AP	55	99323AP	108		

BY BRAND / MARKAYA GÖRE

INDEX

BPW	1
DAF	1-13
HALDEX	13-14
IVECO	15-17
KÖGEL	18
KRONE	19
MAN	19-27
MERCEDES BENZ	28-45
NEOPLAN	45
RENAULT	46-56
SAF	56
SCANIA	57-63
SCHMITZ	64-65
VOLVO	66-75
WABCO	76-91
AMERICAN APPLICATIONS	92-98
OTHER	99-114
STRAPS	115

Ø 102

Length	Liter	Has Bracket ?	APLUS No	Page
170	1	No	99114AP	76

Ø 144

Length	Liter	Has Bracket ?	APLUS No	Page
321	4	No	99116AP	28
411,5	5,4	No	99117AP	28
453	6	No	99118AP	29

Ø 150

Length	Liter	Has Bracket ?	APLUS No	Page
539	8	No	99119AP	46

Ø 154

Length	Liter	Has Bracket ?	APLUS No	Page
224	3	No	99120AP	57
273	4	No	99121AP	19-76
285	3,8	No	99122AP	1
332	5	Yes	99123AP	56
341	5	Yes	99124AP	2-15-18-77
369	5,5	No	99125AP	2
461	7	No	99127AP	3
486	7,4	No	99128AP	57
615	10	No	99129AP	78

Ø 200

Length	Liter	Has Bracket ?	APLUS No	Page
561	15	No	99132AP	46

Ø 206

Length	Liter	Has Bracket ?	APLUS No	Page
242	6	No	99135AP	58-78
242	6	No	99137AP	66
294	8	No	99139AP	20
355	10	No	99143AP	79
362	10	No	99145AP	29
360	10	No	99146AP	30
366	10	No	99150AP	30
371	10	No	99151AP	3-31-79
513	15	No	99153AP	58
515	15	No	99154AP	47-66
526	15	No	99156AP	59
526	15	No	99157AP	15
550	15	No	99160AP	47-67
652	20	No	99161AP	4
674	20	No	99162AP	20
677	20	No	99164AP	31
691	20	No	99167AP	4-16-32
691	20	No	99167AP	56-59-80
991	30	No	99168AP	67-80
1304	40	No	99170AP	21
827	25	No	99216AP	38
709	20	Yes	99306AP	101
215	5	No	99311AP	103
513	15	No	99341AP	63
812	23	No	99349AP	93
812	23	No	99359AP	95
812,5	23	No	99368AP	98

Ø 246

Length	Liter	Has Bracket ?	APLUS No	Page
277	7,5	No	99171AP	32
277	10	No	99173AP	33
379	15	No	99175AP	68
380	15	No	99176AP	5
385	15	No	99177AP	48-68
399	15	No	99178AP	69
410	16	No	99179AP	60-81
495	20	No	99180AP	21-33-81
496,5	20	No	99181AP	34
498	20	No	99182AP	22
500	20	No	99185AP	82
500	20	No	99186AP	34
533	20	No	99189AP	5
570	25	No	99190AP	22
588	25	No	99191AP	48-69
604,5	25	No	99195AP	35
609	25	No	99196AP	16-99
619	25	No	99197AP	6
625	25	No	99199AP	6
645	27	No	99200AP	60-82
709	30	No	99201AP	1-7-35-45-83
714,5	30	No	99203AP	36
719,5	30	No	99204AP	17
720	30	No	99206AP	70
730	30	No	99208AP	23
821	35	No	99209AP	36
850	37	No	99210AP	13-83
915	40	No	99211AP	84
927	40	No	99212AP	7-23-37-49
932,5	40	No	99213AP	37
1365	60	No	99215AP	84
1369	60	No	99217AP	38
852	37	No	99307AP	102
1352	60	No	99312AP	104
839	8	No	99317AP	106
699	25	Yes	99319AP	92
750	47	No	99320AP	92
698,5	24	No	99350AP	94
698,5	24	No	99360AP	95
274	10	No	99362AP	114
699	24	No	99363AP	96
700	24	No	99364AP	96
697	24	No	99365AP	97
698	24	No	99366AP	97
698,5	24	No	99367AP	98
480	20	No	99370AP	114
1150	50	No	99381AP	45

Ø 250

Length	Liter	Has Bracket ?	APLUS No	Page
491	20	No	99218AP	49
597	25	No	99219AP	50
705	30	No	99220AP	50
750	30	No	99221AP	51

Ø 255

Length	Liter	Has Bracket ?	APLUS No	Page
759	35	No	99222AP	70
759	35	No	99223AP	71
927	43,5	No	99316AP	106
650	30	No	99326AP	79

Ø 276

Length	Liter	Has Bracket ?	APLUS No	Page
411,5	20	No	99225AP	39
414	20	No	99227AP	51-85
431	20	No	99229AP	39
490	25	No	99231AP	52-71
494,5	25	No	99233AP	40
500	25	No	99234AP	72
501	25	No	99235AP	52-72
568	30	No	99236AP	61-85
575	30	No	99237AP	73
579	30	No	99238AP	8
8584	30	No	99240AP	40
584,5	30	No	99242AP	41
662,5	35	No	99243AP	41
710	38	No	99244AP	53-73
8740	40	No	99247AP	53
758	40	No	99248AP	42
745	40	No	99249AP	8-86
758	40	No	99250AP	9-24-61-74-86
844	45	No	99254AP	42
1108	50	No	99255AP	74
1108	60	No	99258AP	9-14-43-87
1500	85	No	99259AP	43-87
390	20	No	99260AP	44
760	40	No	99342AP	113
583	30	No	99347AP	44-91

Ø 300

Length	Liter	Has Bracket ?	APLUS No	Page
373	20	No	99261AP	10
515	30	No	99265AP	54
609	36	No	99266AP	10
609	36	No	99267AP	11
609	36	Yes	99268AP	11
700	45	No	99269AP	12
740	45	No	99270AP	88
950	60	No	99271AP	88
966	60	No	99272AP	54
910	60	Yes	99302AP	99
910	60	Yes	99303AP	100
910	60	No	99304AP	100
910	60	No	99305AP	101
912	60	No	99313AP	104
757	50	No	99314AP	105
757	50	Yes	99315AP	105
888	60	No	99322AP	108

Ø 308

Length	Liter	Has Bracket ?	APLUS No	Page
751	47	No	99346AP	93
752	47	No	99358AP	94

Ø 310

Length	Liter	Has Bracket ?	APLUS No	Page
324	20	No	99273AP	24
462	30	No	99275AP	25
483	30	No	99276AP	62
529	35	No	99277AP	25
529	35	No	99278AP	26
563	36	No	99279AP	62
605	40	No	99280AP	26
880	60	No	99284AP	64-89
1150	80	No	99285AP	18
1157	80	No	99286AP	64
620	40	No	99308AP	102
742	50	No	99310AP	103
600	39	No	99321AP	107
1179	8	Yes	99327AP	110

Ø 320

Length	Liter	Has Bracket ?	APLUS No	Page
464	30	No	99287AP	55
586	40	No	99288AP	55
823	60	No	99325AP	109
873	60	No	99348AP	113

Ø 380

Length	Liter	Has Bracket ?	APLUS No	Page
794	80	No	99323AP	108
614	60	No	99324AP	109
610	60	No	99334AP	111
790	80	No	99335AP	111
1417	150	No	99336AP	112

Ø 396

Length	Liter	Has Bracket ?	APLUS No	Page
345	30	No	99290AP	27
417	39	No	99291AP	56-75
495	50	No	99292AP	75
580	60	No	99293AP	12-27-89
743	80	No	99296AP	65
750	80	No	99297AP	19
750	80	No	99298AP	13-17-65-90
915	100	No	99299AP	14-63-90
1067	120	No	99318AP	107

Ø 440

Length	Liter	Has Bracket ?	APLUS No	Page
1315	180	No	99337AP	112

BPW

APLUS No	Comparison No	Oem Page
99201AP	1519219	1
99201AP	0220041300	1

DAF

APLUS No	Comparison No	Oem Page
99122AP	1227894	1
99124AP	1506424	2
99125AP	1616336	2
99125AP	1733548	2
99127AP	1616335	3
99127AP	1733547	3
99151AP	1505413	3
99161AP	1701700	4
99161AP	ABRD557	4
99167AP	1505414	4
99167AP	ACHA006	4
99176AP	1524737	5
99189AP	1616334	5
99189AP	1733546	5
99189AP	1227891	5
99197AP	1616333	6
99199AP	1694140	6
99201AP	1506425	7
99212AP	1505416	7
99238AP	1402284	8
99238AP	ABRA383	8
99249AP	BBU1321	8
99250AP	1506426	9
99258AP	1505417	9
99261AP	1227887	10
99261AP	1233666	10
99261AP	1616331	10
99266AP	1227888	10
99266AP	1616332	10
99266AP	1733544	10
99267AP	1696171	11
99268AP	1685296	11
99268AP	1691625	11
99269AP	6310280	12
99293AP	1505422	12
99293AP	1524577	12
99293AP	1935518	12
99298AP	0865720	13
99298AP	1446700	13
99298AP	1506423	13

AMERICAN APPLICATIONS

APLUS No	Comparison No	Oem Page
99319AP	X1212	92
99320AP	X1213	92
99346AP	X1217	93
99349AP	X1218	93
99350AP	X1219	94
99358AP	X1227	94
99359AP	X1228	95
99360AP	X1229	95
99363AP	X1233	96
99364AP	X1234	96
99365AP	X1235	97
99366AP	X1236	97
99367AP	X1237	98
99368AP	X1238	98

HALDEX

APLUS No	Comparison No	Oem Page
99210AP	030001319D	13
99258AP	030360809	14
99299AP	030352209	14

IVECO

APLUS No	Comparison No	Oem Page
99124AP	500404034	15
99124AP	504047686	15
99124AP	504197584	15
99157AP	4803545	15
99157AP	504047697	15
99157AP	504197586	15
99167AP	99452637	16
99167AP	98461955	16
99196AP	504197589	16
99196AP	5801544994	16
99204AP	504197590	17
99204AP	5949779746	17
99298AP	504197591	17
99298AP	5801545818	17

KÖGEL

APLUS No	Comparison No	Oem Page
99124AP	322796	18
99285AP	115483	18

KRONE

APLUS No	Comparison No	Oem Page
99297AP	505821336	19

NEOPLAN

APLUS No	Comparison No	Oem Page
99201AP	07030030	45

SAF

APLUS No	Comparison No	Oem Page
99167AP	4105000200	56

SCHMITZ

APLUS No	Comparison No	Oem Page
99284AP	050459	64
99286AP	1189864	64
99296AP	1009330	65
99296AP	115826	65
99296AP	1189863	65
99298AP	050461	65

OTHERS

APLUS No	Comparison No	Oem Page
99196AP	275001000025366	99
99302AP	SPA190	99
99303AP	SPA188	100
99303AP	SPA185M	100
99304AP	SPA189	100
99305AP	SPA212	101
99306AP	SPA181M	101
99307AP	SPA1006	102
99308AP	SPA1009	102
99310AP	SPA1030	103
99311AP	SPA1000	103
99312AP	SPA1010	104
99313AP	SPA184M	104
99314AP	SPA182M	105
99315AP	SPA183M	105
99316AP	X1035	106
99317AP	SPA179M	106
99318AP	SPA1016	107
99321AP	X1021	107
99322AP	X1027	108
99323AP	X1022	108
99324AP	X1023	109
99325AP	X1024	109
99326AP	X1025	110
99327AP	X1026	110
99334AP	X1107	111
99335AP	X1108	111
99336AP	X1168	112
99337AP	X1169	112
99342AP	X1177	113
99348AP	X1182	113
99362AP	81514010147	114
99370AP	X1324	114

RENAULT

APLUS No	Comparison No	Oem Page
99119AP	5010525415	46
99132AP	5010525437	46
99154AP	7420579600	47
99160AP	7420904405	47
99177AP	7421187782	48
99191AP	7420904407	48
99212AP	74320101	49
99212AP	74320101	49
99218AP	5010525442	49
99219AP	5010525445	50
99220AP	5010525447	50
99221AP	5010525446	51
99227AP	5021170381	51
99231AP	7420579604	52
99235AP	7421187789	52
99244AP	7421187793	53
99247AP	5010525149	53
99265AP	5010525418	54
99272AP	5021170393	54
99272AP	1518200	54
99287AP	5010525419	55
99288AP	5010525449	55
99291AP	7421187795	56

MERCEDES BENZ

APLUS No	Comparison No	Oem Page	APLUS No	Comparison No	Oem Page
99116AP	0044320501	28	99209AP	0064324601	36
99116AP	0054323001	28	99209AP	3754323901	36
99116AP	0064323401	28	99212AP	0004322101	37
99117AP	0054323101	28	99212AP	0034322301	37
99117AP	0064323501	28	99213AP	0044320001	37
99117AP	0044320601	28	99213AP	0054322901	37
99118AP	0034320601	29	99213AP	0064324701	37
99118AP	0054322001	29	99216AP	0044326801	38
99145AP	0004323101	29	99216AP	0054324301	38
99146AP	0004329001	30	99216AP	0064323901	38
99146AP	0024328201	30	99217AP	0054323701	38
99146AP	0024328401	30	99217AP	0064324901	38
99150AP	0044320801	30	99225AP	0044323101	39
99150AP	0054323301	30	99225AP	0054323601	39
99150AP	0064323701	30	99225AP	0064325201	39
99151AP	0074321101	31	99229AP	0014326101	39
99151AP	0034320801	31	99229AP	0024323801	39
99164AP	0064323801	31	99229AP	0034321601	39
99164AP	0054324201	31	99233AP	0034329401	40
99167AP	0004322001	32	99233AP	0054322601	40
99167AP	0034321101	32	99233AP	0064325301	40
99171AP	0044320701	32	99240AP	0044324301	40
99171AP	0054323201	32	99240AP	0054323901	40
99171AP	0064324001	32	99240AP	0064325501	40
99173AP	0064324201	33	99242AP	0054322201	41
99173AP	0034324101	33	99242AP	0064325401	41
99173AP	0064328001	33	99243AP	0034329501	41
99180AP	0004323201	33	99243AP	0054322701	41
99181AP	0044321901	34	99243AP	0064325601	41
99181AP	0054323401	34	99248AP	0034323901	42
99181AP	0064324301	34	99248AP	0054322501	42
99186AP	0034321301	34	99248AP	0064325701	42
99186AP	0004324801	34	99254AP	0034329901	42
99186AP	0004325101	34	99254AP	0054322801	42
99195AP	0044324201	35	99254AP	0064325801	42
99195AP	0054323801	35	99258AP	0034322701	43
99195AP	0064324401	35	99259AP	0004321101	43
99201AP	0014326901	35	99260AP	0004326501	44
99201AP	0034321801	35	99260AP	0034321401	44
99203AP	0034323201	36	99347AP	0034322001	44
99203AP	0054322301	36	99347AP	0024320801	44
99203AP	0064324501	36	99347AP	0014320201	44
99209AP	0054323501	36	99381AP	0064324801	45

MAN

APLUS No	Comparison No	Oem Page	APLUS No	Comparison No	Oem Page
99121AP	81514010037	19	99250AP	81514010019	24
99121AP	81514010078	19	99250AP	81514010145	24
99121AP	81514010114	19	99273AP	81514010228	24
99139AP	81514010179	20	99273AP	81514010238	24
99139AP	81514010203	20	99273AP	81514010257	24
99139AP	81514010237	20	99275AP	81514010180	25
99162AP	81514010128	20	99275AP	81514010204	25
99162AP	81514010202	20	99275AP	81514010239	25
99170AP	81514010135	21	99277AP	81514010240	25
99170AP	81514010213	21	99277AP	81514016014	25
99180AP	81514010139	21	99278AP	81514010259	26
99182AP	81514010129	22	99278AP	81514016038	26
99182AP	81514010207	22	99278AP	81514016156	26
99190AP	81514010024	22	99280AP	81514010182	26
99190AP	81514010032	22	99280AP	81514010206	26
99190AP	81514010062	22	99280AP	81514016015	26
99208AP	81514010133	23	99290AP	81514010232	27
99208AP	81514010212	23	99290AP	81514010233	27
99208AP	83514010512	23	99290AP	81514010242	27
99212AP	81514010142	23	99293AP	88514016219	27

WABCO

APLUS No	Comparison No	Oem Page	APLUS No	Comparison No	Oem Page
99114AP	9510050100	76	99210AP	4510373010	83
99121AP	9500200080	76	99210AP	9505370010	83
99123AP	4510054800	77	99211AP	4510403010	84
99123AP	9502050010	77	99215AP	9505600020	84
99124AP	9501050010	77	99227AP	9507200050	85
99129AP	9501100020	78	99236AP	9507300050	85
99135AP	9504060010	78	99249AP	4510403110	86
99143AP	9504109020	79	99250AP	9507400020	86
99151AP	9504100040	79	99258AP	9507600020	87
99167AP	9504200030	80	99259AP	4510853010	87
99167AP	9504200100	80	99270AP	9508450010	88
99168AP	9504300010	80	99271AP	9500600090	88
99179AP	9505160030	81	99284AP	9500600030	89
99180AP	9505200030	81	99293AP	9500600040	89
99185AP	9505200020	82	99298AP	9500800020	90
99200AP	9505270040	82	99299AP	9501000020	90
99201AP	9505300020	83	99347AP	9507300070	91

SCANIA

APLUS No	Comparison No	Oem Page
99120AP	1887788	57
99128AP	1360400	57
99128AP	1383853	57
99135AP	1935522	58
99153AP	1445452	58
99156AP	1360401	59
99167AP	1935524	59
99179AP	1332534	60
99179AP	1332535	60
99179AP	1377865	60
99200AP	1332532	60
99200AP	1332533	60
99200AP	1377864	60
99236AP	1357950	61
99236AP	1383777	61
99236AP	488217	61
99250AP	1935528	61
99276AP	1778889	62
99279AP	1448884	62
99299AP	1935520	63
99341AP	1792544	63

VOLVO

APLUS No	Comparison No	Oem Page
99137AP	20579593	66
99154AP	20579600	66
99160AP	20904405	67
99168AP	3117304	67
99168AP	20850902	67
99175AP	21048254	68
99175AP	21048245	68
99177AP	21187782	68
99178AP	20772295	69
99191AP	20904407	69
99206AP	20714522	70
99222AP	20946636	70
99223AP	20946637	71
99231AP	20948176	71
99231AP	20579604	71
99234AP	20714520	72
99235AP	21187789	72
99237AP	20579606	73
99237AP	20485246	73
99244AP	21187793	73
99250AP	11117328	74
99255AP	020984637	74
99291AP	21187795	75
99292AP	1628927	75
99292AP	20392308	75
99292AP	20485247	75





BPW

99201AP

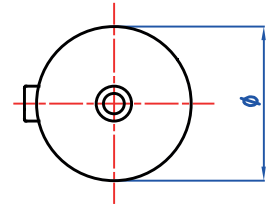
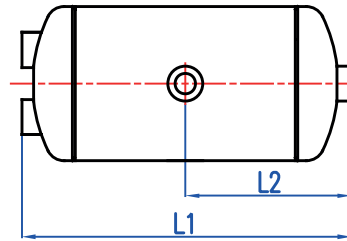
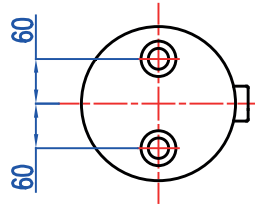
AIR TANK

HAVA TANKI



OEM / COMPARISON NO		LITER LITRE	∅	↔ L1 / L2			TYPE / TİP
0220041300 1519219	15,5 bar	30	246 mm	709 / 359 mm	12 kg	M22x1,5	





DAF

99122AP

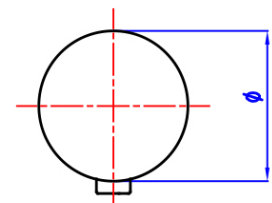
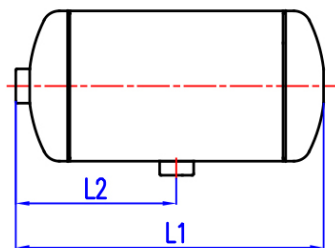
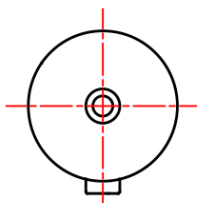
AIR TANK

HAVA TANKI



OEM / COMPARISON NO		LITER LITRE	∅	↔ L1 / L2			TYPE / TİP
1227894	12,5 bar	3,8	154 mm	285 / 149 mm	3,4 kg	M22x1,5	





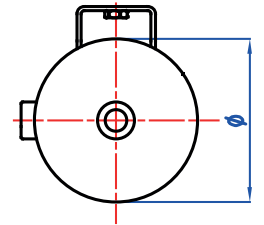
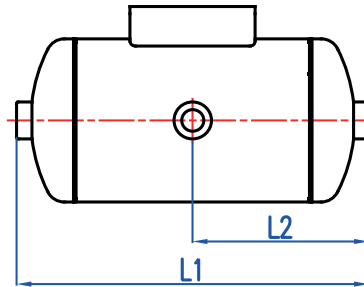
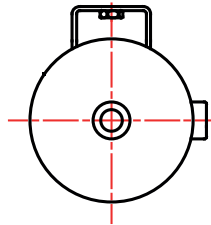

DAF

99124AP

AIR TANK

HAVA TANKI



OEM / COMPARISON NO		LITER LİTRE	Ø	↔ L1 / L2			TYPE / TİP
322796	20 bar	5	154 mm	341 / 171 mm	6,5 kg	M22x1,5	  





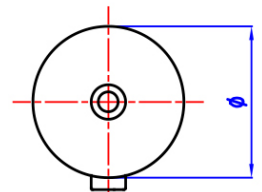
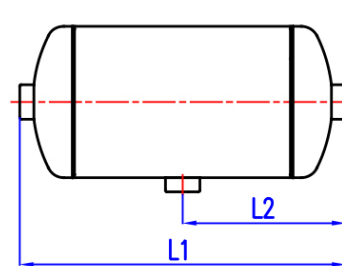
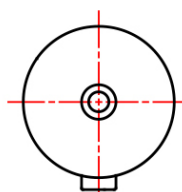

DAF

99125AP

AIR TANK

HAVA TANKI



OEM / COMPARISON NO		LITER LİTRE	Ø	↔ L1 / L2			TYPE / TİP
1616336 1733548	12,5 bar	5,5	154 mm	369 / 185 mm	4,1 kg	M22x1,5	  





DAF

99127AP

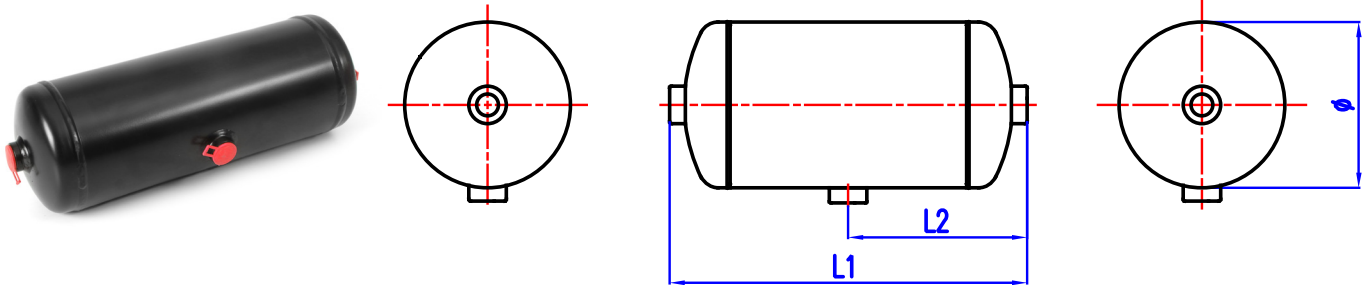
AIR TANK

HAVA TANKI



OEM / COMPARISON NO		LITER LITRE	Ø	↔ L1 / L2			TYPE / TİP
1616335 1733547	12,5 bar	7	154 mm	461 / 231 mm	5 kg	M22x1,5	





DAF

99151AP

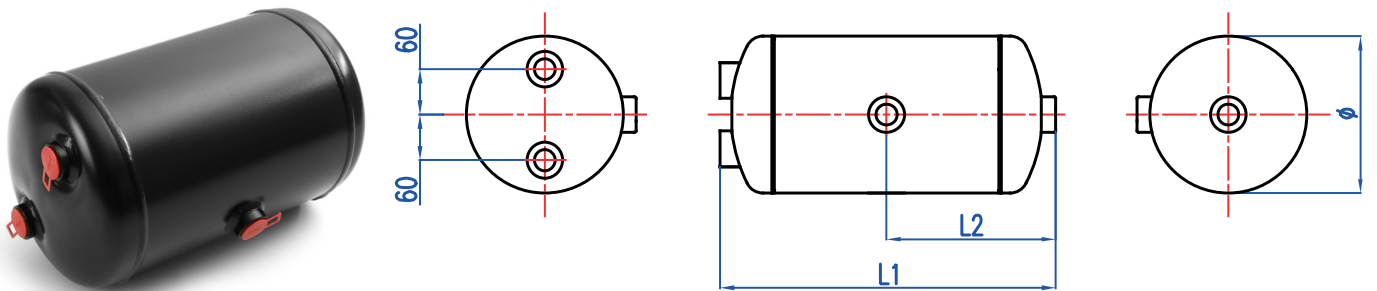
AIR TANK

HAVA TANKI



OEM / COMPARISON NO		LITER LITRE	Ø	↔ L1 / L2			TYPE / TİP
1505413	15,5 bar	10	206 mm	370 / 190 mm	5,9 kg	M22x1,5	



DAF

99161AP

AIR TANK

HAVA TANKI



OEM / COMPARISON NO		LITER LİTRE	∅	↔ L1 / L2			TYPE / TİP
1701700 ABRD557	15,5 bar	20	206 mm	692 / 351 mm	9,9 kg	M22x1,5	





DAF

99167AP

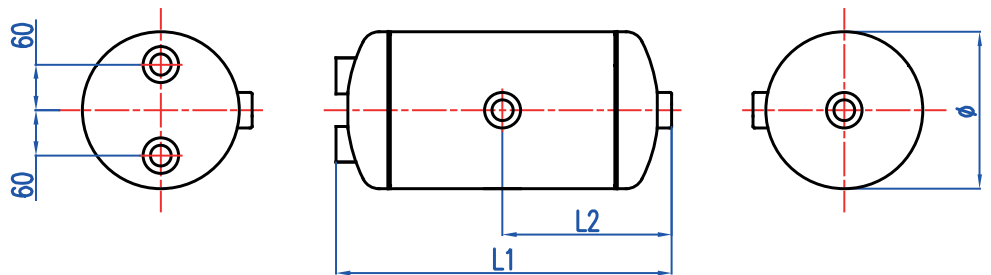
AIR TANK

HAVA TANKI



OEM / COMPARISON NO		LITER LİTRE	∅	↔ L1 / L2			TYPE / TİP
1505414	15,5 bar	20	206 mm	692 / 351 mm	9,9 kg	M22x1,5	





DAF

99180AP

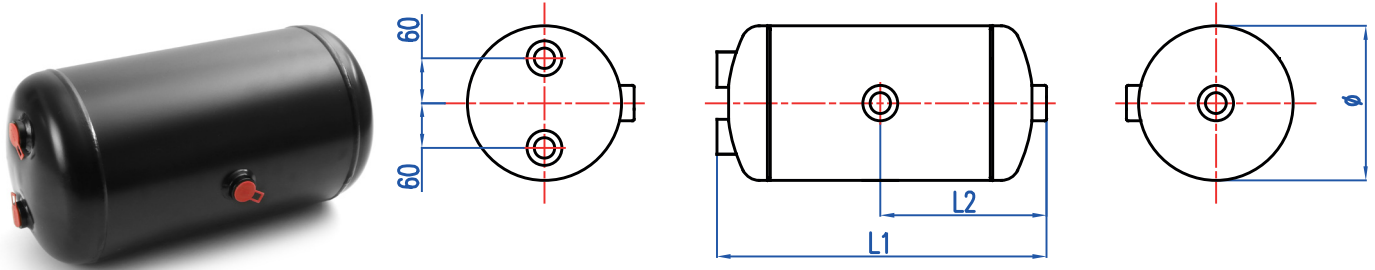
AIR TANK

HAVA TANKI



OEM / COMPARISON NO		LITER LİTRE	Ø	↔ L1 / L2			TYPE / TİP
1505415	15,5 bar	20	246 mm	495 / 252 mm	8,9 kg	M22x1,5	





DAF

99189AP

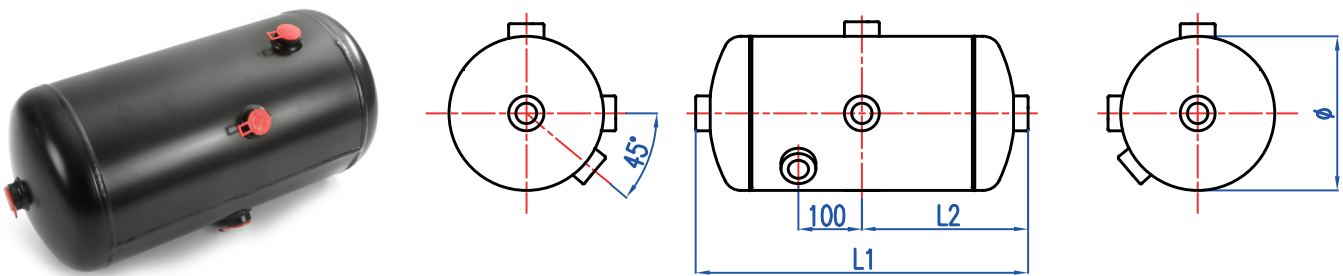
AIR TANK

HAVA TANKI



OEM / COMPARISON NO		LITER LİTRE	Ø	↔ L1 / L2			TYPE / TİP
1227891 1616334 1733546	12,5 bar	20	246 mm	533 / 287 mm	9,3 kg	M22x1,5	





DAF

99197AP

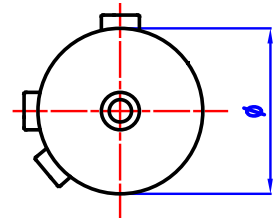
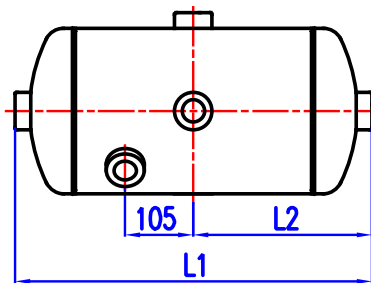
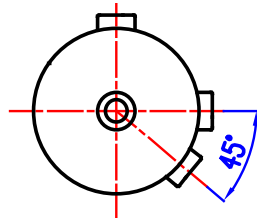
AIR TANK

HAVA TANKI



OEM / COMPARISON NO		LITER LİTRE	Ø	↔ L1 / L2			TYPE / TİP
1616333	12,5 bar	25	246 mm	619 / 343 mm	10,6 kg	M22x1,5	



DAF

99199AP

AIR TANK

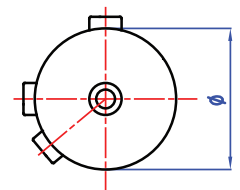
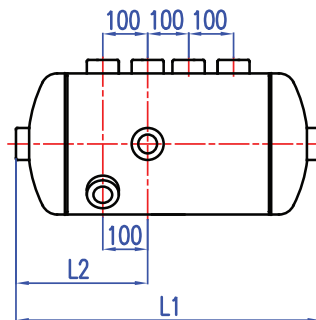
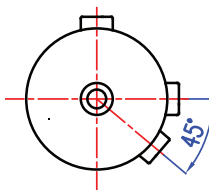
HAVA TANKI

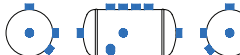

OEM / COMPARISON NO		LITER LİTRE	Ø	↔ L1 / L2			TYPE / TİP
1694140	12,5 bar	25	246 mm	625 / 352 mm	12,2 kg	M22x1,5	





DAF

99201AP

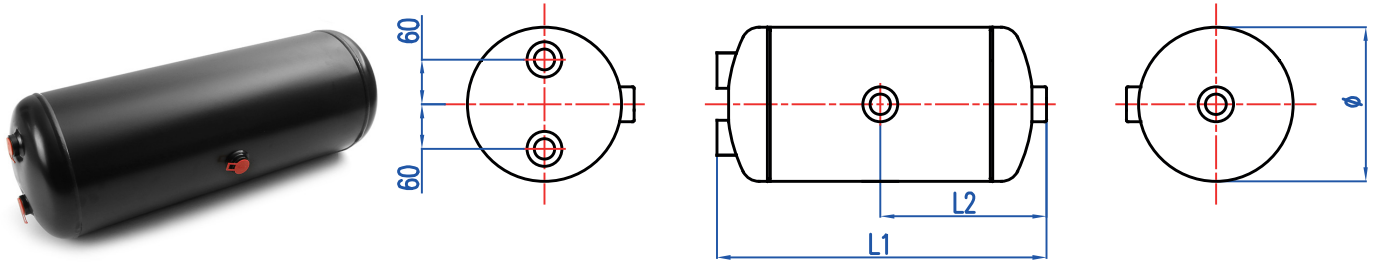
AIR TANK

HAVA TANKI



OEM / COMPARISON NO		LITER LİTRE	Ø	↔ L1 / L2			TYPE / TİP
1506425	15,5 bar	30	246 mm	709 / 359 mm	12 kg	M22x1,5	





DAF

99212AP

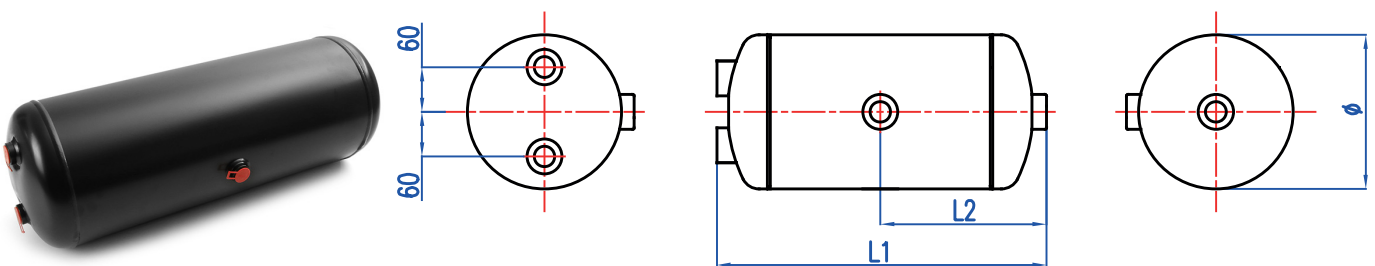
AIR TANK

HAVA TANKI



OEM / COMPARISON NO		LITER LİTRE	Ø	↔ L1 / L2			TYPE / TİP
1505416	15,5 bar	40	246 mm	927 / 468 mm	15,4 kg	M22x1,5	



DAF

99238AP

AIR TANK

HAVA TANKI



OEM / COMPARISON NO		LITER LITRE	∅	↔ L1 / L2			TYPE / TİP
1402284 ABRA383	15,5 bar	30	276 mm	745 / 377 mm	13,8 kg	M22x1,5	





DAF

99249AP

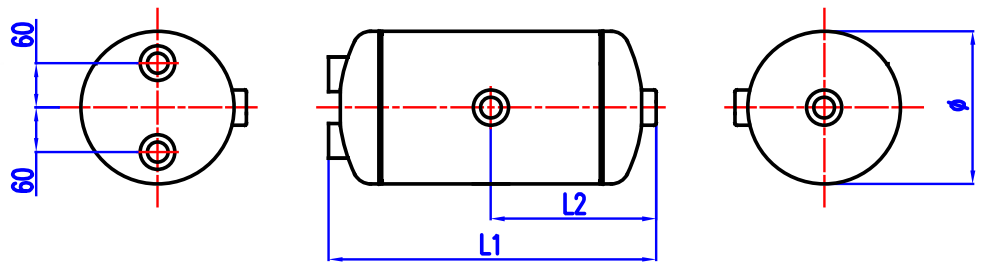
AIR TANK

HAVA TANKI



OEM / COMPARISON NO		LITER LITRE	∅	↔ L1 / L2			TYPE / TİP
BBU1321	12,5 bar	40	276 mm	745 / 377 mm	13,8 kg	M22x1,5	



DAF

99250AP

AIR TANK

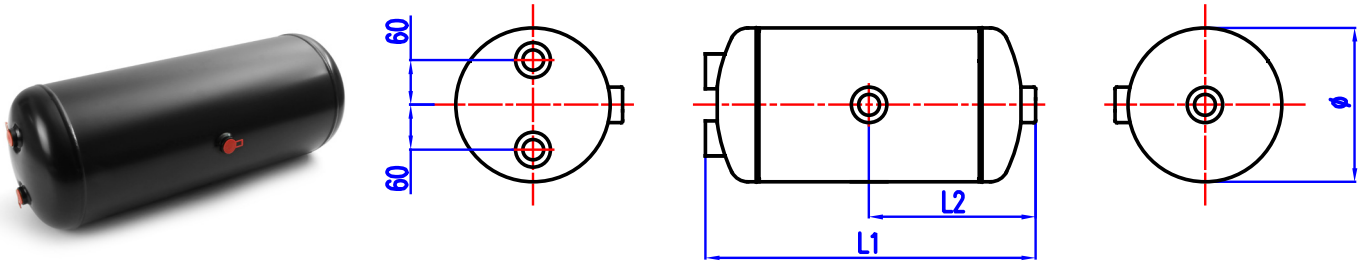
HAVA TANKI

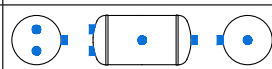

OEM / COMPARISON NO		LITER LITRE	Ø	↔ L1 / L2			TYPE / TİP
1506426	15,5 bar	40	276 mm	760 / 385 mm	14,5 kg	M22x1,5	





DAF

99258AP

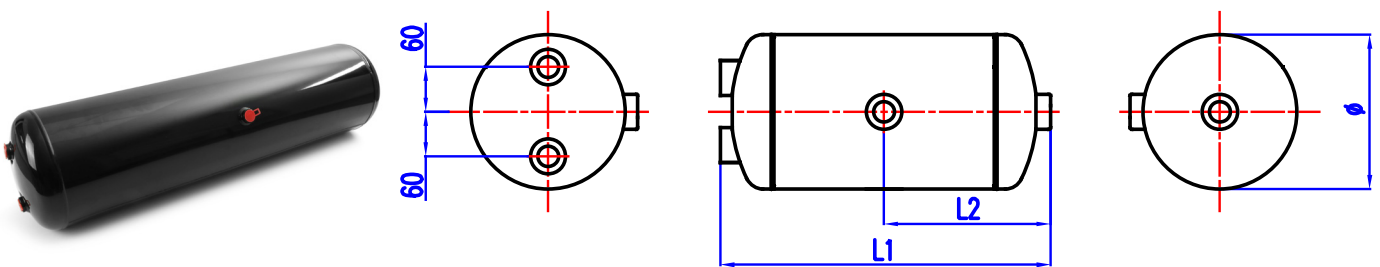
AIR TANK

HAVA TANKI



OEM / COMPARISON NO		LITER LITRE	Ø	↔ L1 / L2			TYPE / TİP
1505417	15,5 bar	60	276 mm	1108 / 559 mm	20,5 kg	M22x1,5	





DAF

99261AP

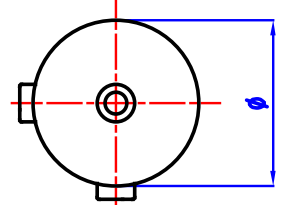
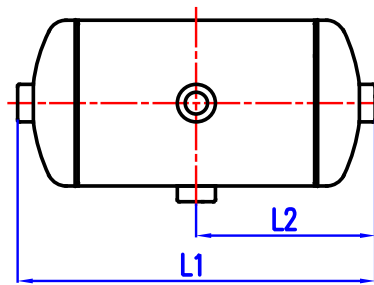
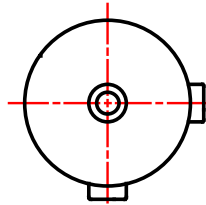
AIR TANK

HAVA TANKI



OEM / COMPARISON NO	 12,5 bar	LITER LITRE	Ø	↔ L1 / L2			TYPE / TIP
1227887 1233666 1616331 501207	12,5 bar	20	300 mm	373 / 187 mm	8,5 kg	M22x1,5	





DAF

99266AP

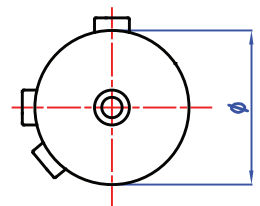
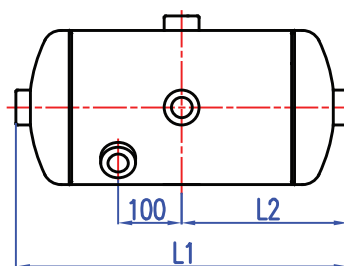
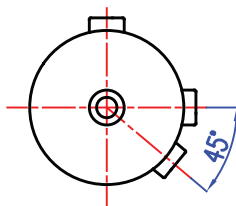
AIR TANK

HAVA TANKI



OEM / COMPARISON NO	 12,5 bar	LITER LITRE	Ø	↔ L1 / L2			TYPE / TIP
1227888 1616332 1733544	12,5 bar	36	300 mm	609 / 334 mm	12,8 kg	M22x1,5	





DAF

99267AP

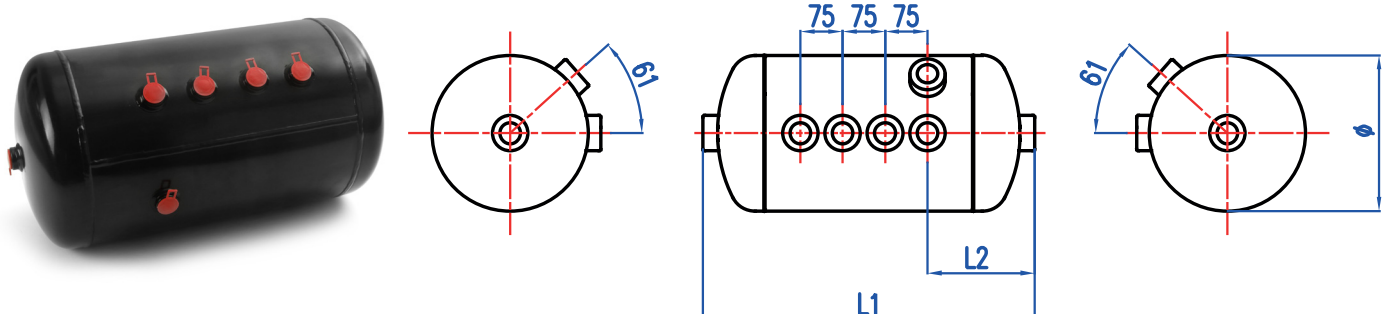
AIR TANK

HAVA TANKI



OEM / COMPARISON NO		LITER LITRE	Ø	↔ L1 / L2			TYPE / TİP
1696171	12,5 bar	36	300 mm	609 / 200 mm	13,1 kg	M22x1,5	



DAF

99268AP

AIR TANK

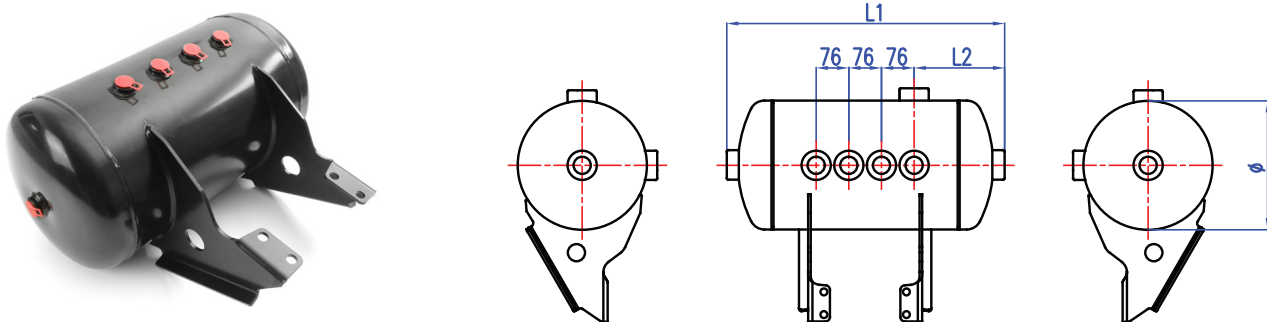
HAVA TANKI

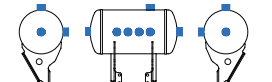

OEM / COMPARISON NO		LITER LITRE	Ø	↔ L1 / L2			TYPE / TİP
1685296 1691625	12,5 bar	36	300 mm	609 / 191 mm	16,8 kg	M22x1,5	





DAF

99269AP

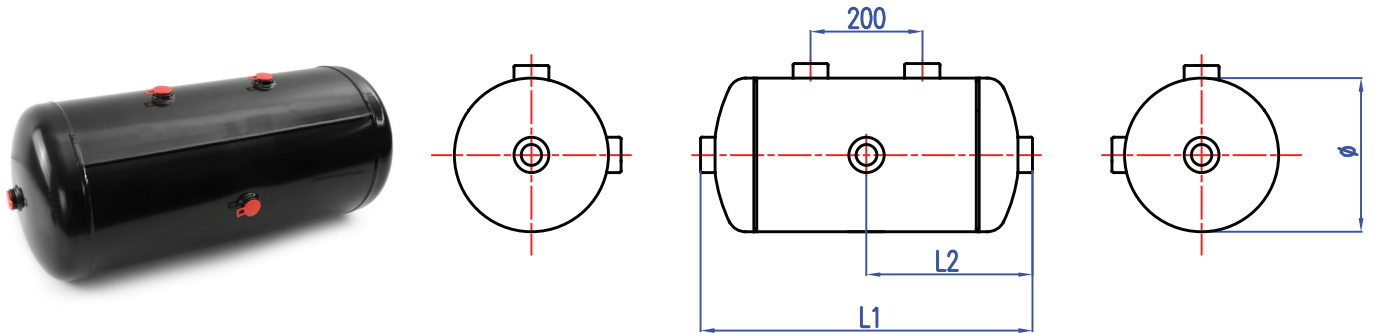
AIR TANK

HAVA TANKI



OEM / COMPARISON NO		LITER LİTRE	Ø	↔ L1 / L2			TYPE / TİP
6310280	12,5 bar	45	300 mm	748 / 374 mm	15,5 kg	M22x1,5	





DAF

99293AP

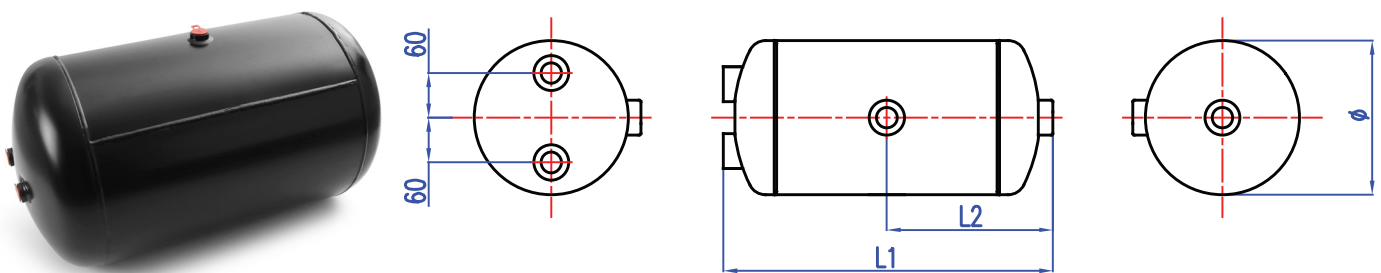
AIR TANK

HAVA TANKI



OEM / COMPARISON NO		LITER LİTRE	Ø	↔ L1 / L2			TYPE / TİP
1505422 1524577 1935518	12,5 bar	60	396 mm	580 / 295 mm	20,1 kg	M22x1,5	





DAF

99298AP

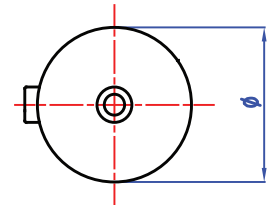
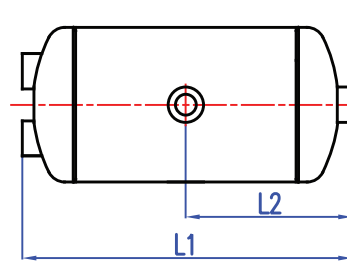
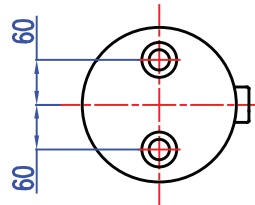
AIR TANK

HAVA TANKI



OEM / COMPARISON NO		LITER LITRE	Ø	↔ L1 / L2			TYPE / TİP
0865720 1446700 1506423	12,5 bar	80	396 mm	750 / 380 mm	25 kg	M22x1,5	





HALDEX

99210AP

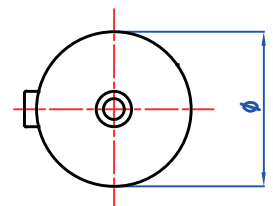
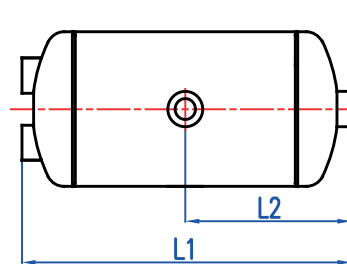
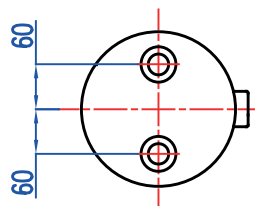
AIR TANK

HAVA TANKI



OEM / COMPARISON NO		LITER LITRE	Ø	↔ L1 / L2			TYPE / TİP
030001319D	15,5 bar	37	246 mm	862 / 436 mm	14,3 kg	M22x1,5	





HALDEX

99258AP

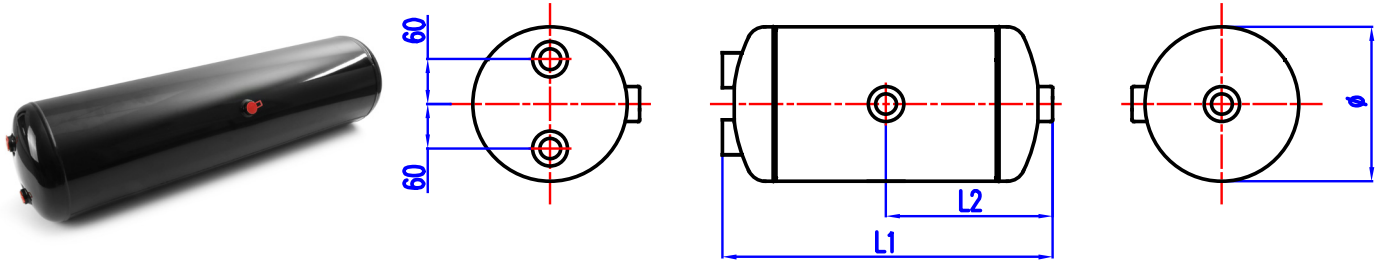
AIR TANK

HAVA TANKI



OEM / COMPARISON NO		LITER LİTRE	Ø	↔ L1 / L2			TYPE / TİP
030360809	15,5 bar	60	276 mm	1108 / 559 mm	20,5 kg	M22x1,5	





HALDEX

99299AP

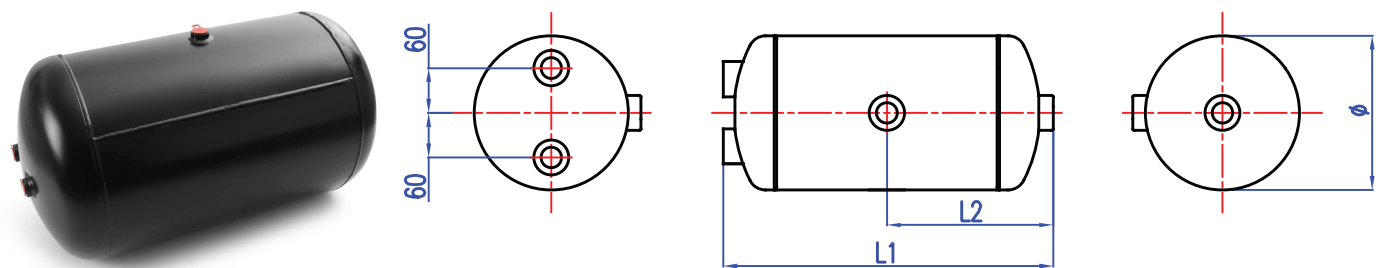
AIR TANK

HAVA TANKI



OEM / COMPARISON NO		LITER LİTRE	Ø	↔ L1 / L2			TYPE / TİP
030352209	10 bar	100	396 mm	915 / 462 mm	29,9 kg	M22x1,5	





IVECO

99124AP

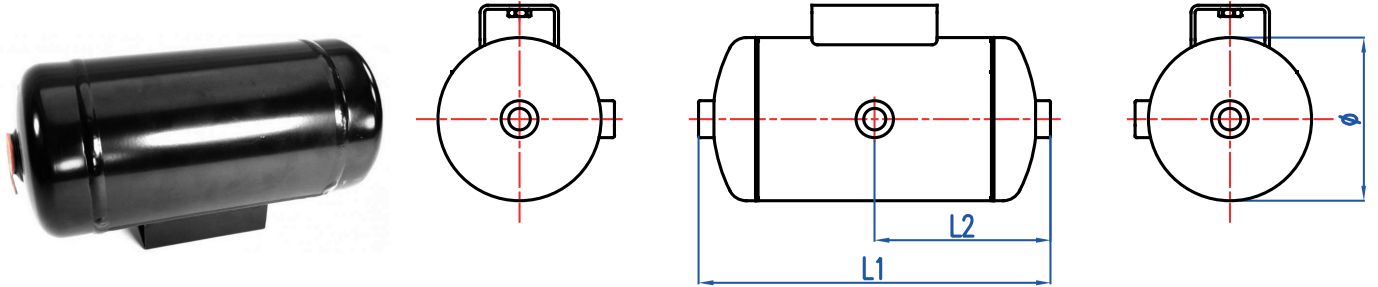
AIR TANK

HAVA TANKI



OEM / COMPARISON NO		LITER LITRE	Ø	↔ L1 / L2			TYPE / TIP
500404034 504047686 504197584 5949779739 98480826 98492453	20 bar	5	154 mm	341 / 171 mm	6,5 kg	M22x1,5	





IVECO

99157AP

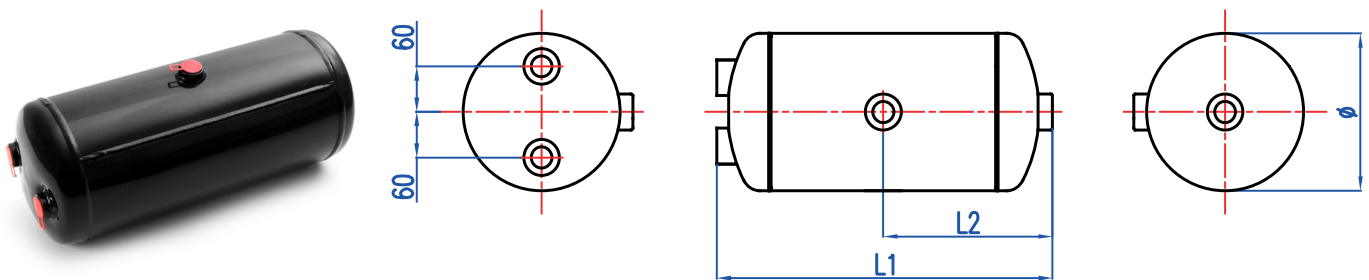
AIR TANK

HAVA TANKI



OEM / COMPARISON NO		LITER LITRE	Ø	↔ L1 / L2			TYPE / TIP
4803545 504047697 504197586 5949780684 98480832	15,5 bar	15	206 mm	526 / 268 mm	7,8 kg	M22x1,5	





IVECO

99167AP

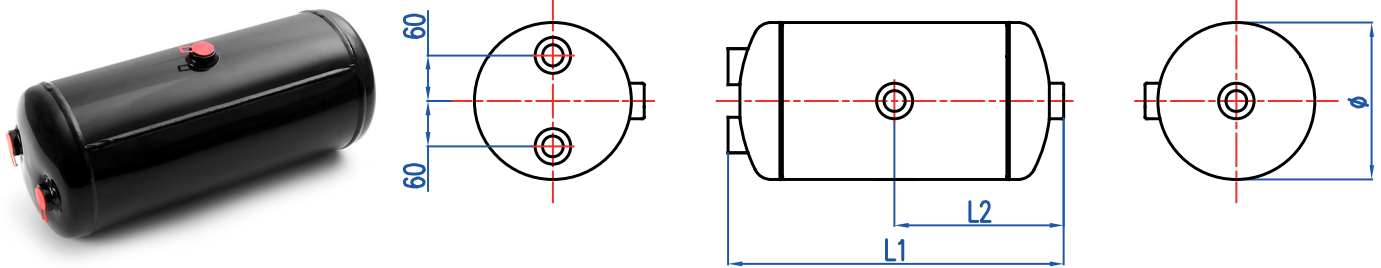
AIR TANK

HAVA TANKI



OEM / COMPARISON NO		LITER LITRE	∅	↔ L1 / L2			TYPE / TİP
98461955 99452637	15,5 bar	20	206 mm	692 / 351 mm	9,9 kg	M22x1,5	





IVECO

99196AP

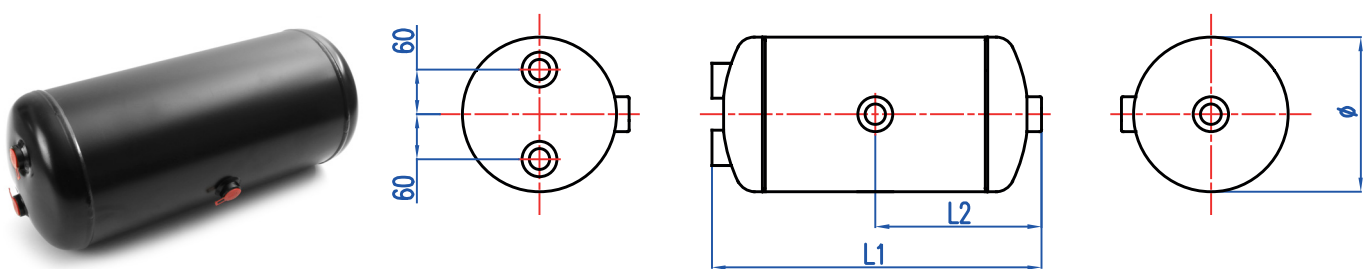
AIR TANK

HAVA TANKI



OEM / COMPARISON NO		LITER LITRE	∅	↔ L1 / L2			TYPE / TİP
504197589 5801544994	15,5 bar	25	246 mm	610 / 310 mm	10,6 kg	M22x1,5	

IVECO

99204AP

AIR TANK

HAVA TANKI

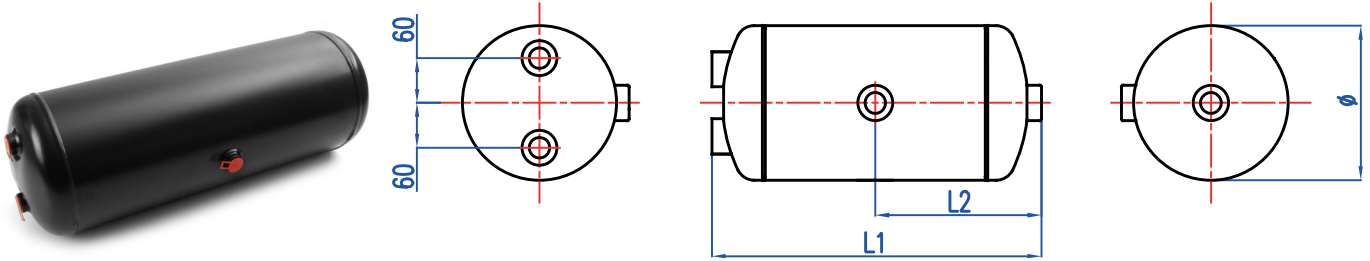

OEM / COMPARISON NO		LITER LİTRE	Ø	↔ L1 / L2			TYPE / TİP
504197590 5949779746	15,5 bar	30	246 mm	720 / 365 mm	12,2 kg	M22x1,5	

IVECO

99298AP

AIR TANK

HAVA TANKI

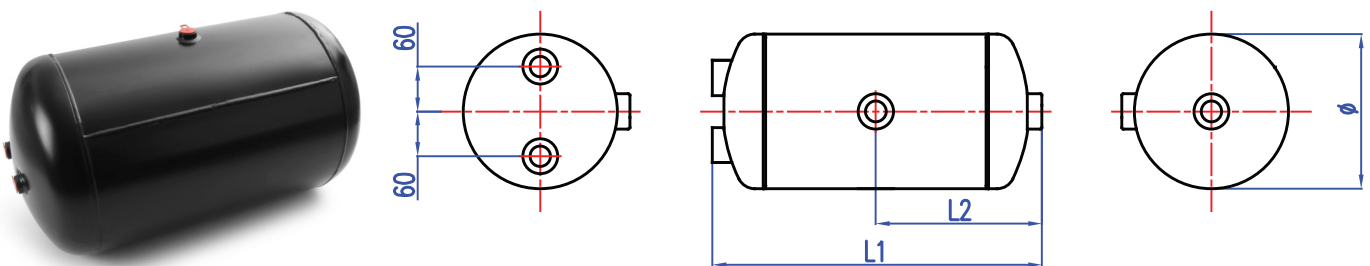

OEM / COMPARISON NO		LITER LİTRE	Ø	↔ L1 / L2			TYPE / TİP
504197591 5801545818	12,5 bar	80	396 mm	750 / 380 mm	25 kg	M22x1,5	





KÖGEL

99124AP

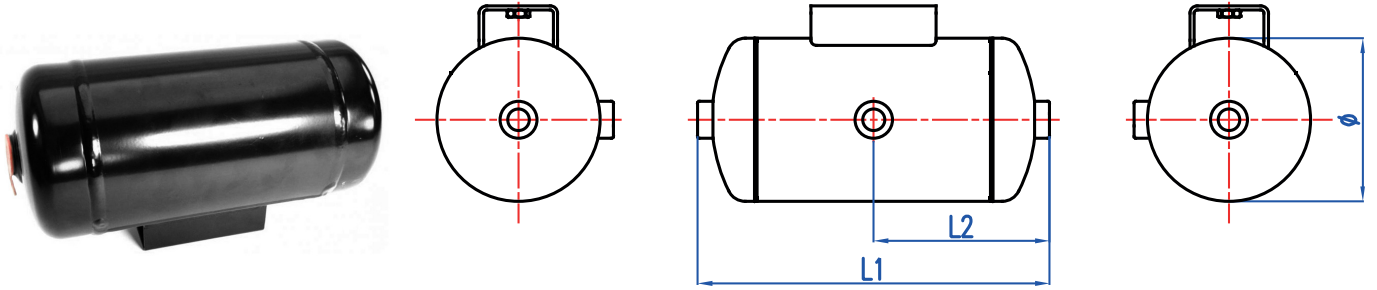
AIR TANK

HAVA TANKI



OEM / COMPARISON NO	 20 bar	LITER LITRE	Ø	↔ L1 / L2	 6,5 kg	 M22x1,5	TYPE / TİP
322796	20 bar	5	154 mm	341 / 171 mm	6,5 kg	M22x1,5	





KÖGEL

99285AP

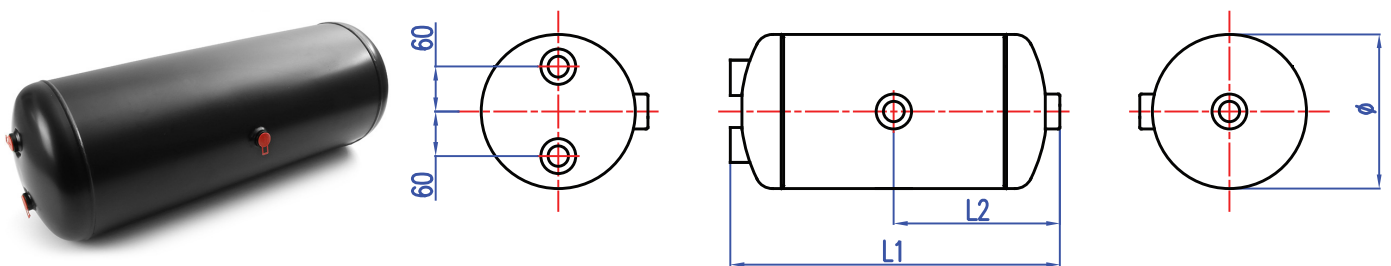
AIR TANK

HAVA TANKI



OEM / COMPARISON NO	 12,5 bar	LITER LITRE	Ø	↔ L1 / L2	 23,9 kg	 M22x1,5	TYPE / TİP
115483	12,5 bar	80	310 mm	1150 / 580 mm	23,9 kg	M22x1,5	



KRONE

99297AP

AIR TANK

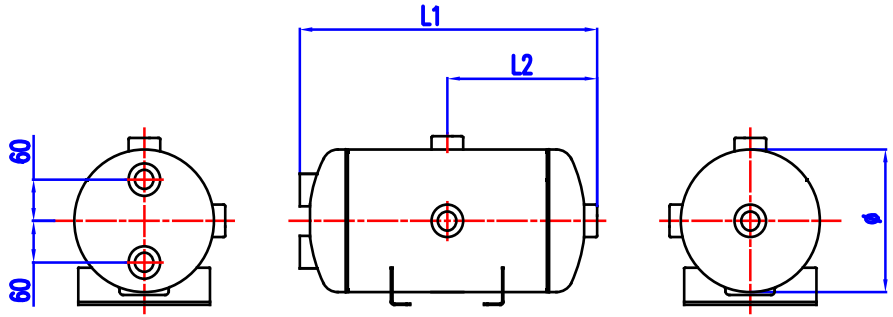
HAVA TANKI

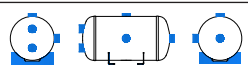

OEM / COMPARISON NO		LITER LITRE	Ø	↔ L1 / L2			TYPE / TİP
505821336	10 bar	80	396 mm	750 / 380 mm	26,9 kg	M22x1,5	



MAN

99121AP

AIR TANK

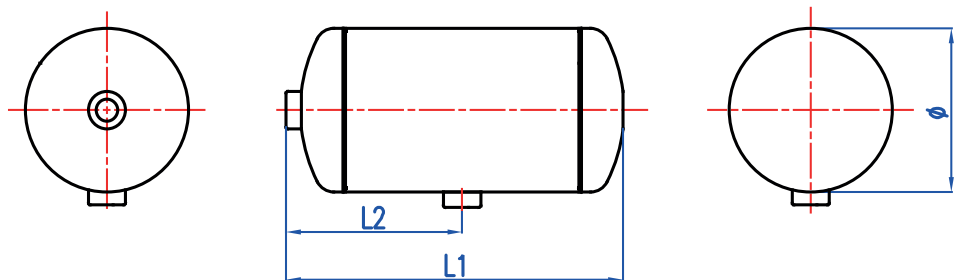
HAVA TANKI

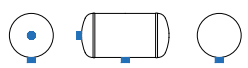

OEM / COMPARISON NO		LITER LITRE	Ø	↔ L1 / L2			TYPE / TİP
81514010037	12,5 bar	4	154 mm	273 / 143 mm	2,5 kg	M22x1,5	
81514010078							
81514010114							
81514010120							
81514010194							
81514010224							
81515010120							
83514010515							





MAN

99139AP

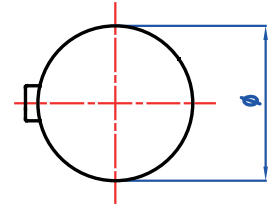
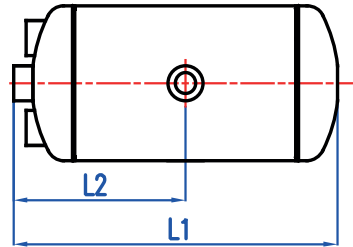
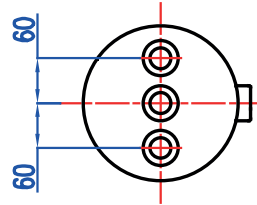
AIR TANK

HAVA TANKI



OEM / COMPARISON NO	 12,5 bar	LITER LİTRE	Ø	↔ L1 / L2	 5 kg	 M22x1,5	TYPE / TİP
81514010179 81514010203 81514010237 81514010248 81514010252 81514016016		8	206 mm	294 / 154 mm			





MAN

99162AP

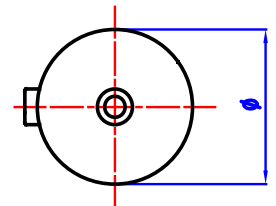
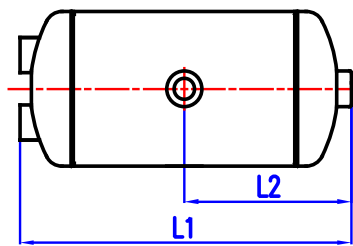
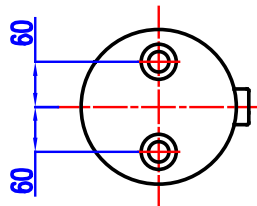
AIR TANK

HAVA TANKI



OEM / COMPARISON NO	 15,5 bar	LITER LİTRE	Ø	↔ L1 / L2	 9,7 kg	 M22x1,5	TYPE / TİP
81514010128 81514010202		20	206 mm	674 / 342 mm			



MAN

99170AP

AIR TANK

HAVA TANKI



OEM / COMPARISON NO		LITER LITRE	∅	↔ L1 / L2			TYPE / TİP
81514010135 81514010213	12,5 bar	40	206 mm	495 / 252 mm	8,9 kg	M22x1,5	



MAN

99180AP

AIR TANK

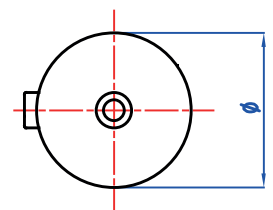
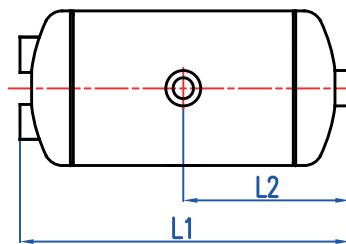
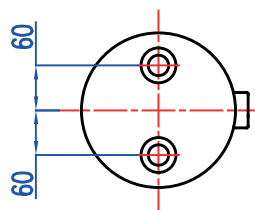
HAVA TANKI

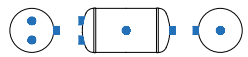

OEM / COMPARISON NO		LITER LITRE	∅	↔ L1 / L2			TYPE / TİP
88514016204	15,5 bar	20	246 mm	495 / 252 mm	8,9 kg	M22x1,5	



MAN

99182AP

AIR TANK

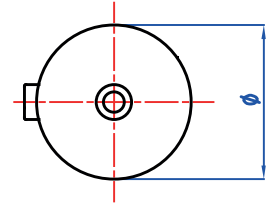
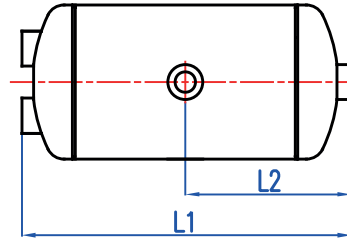
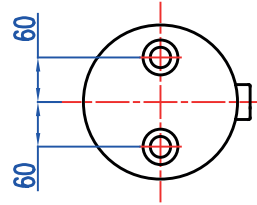
HAVA TANKI

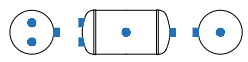

OEM / COMPARISON NO		LITER LİTRE	Ø	↔ L1 / L2			TYPE / TİP
81514010129 81514010207	15,5 bar	20	246 mm	498 / 249 mm	8,6 kg	M22x1,5	





MAN

99190AP

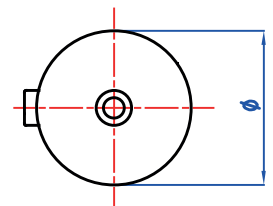
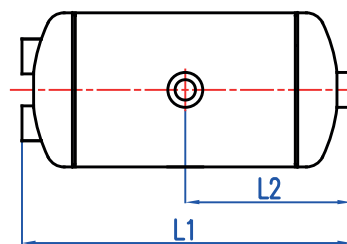
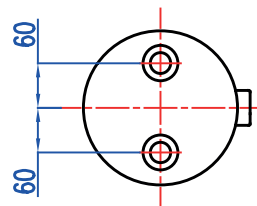
AIR TANK

HAVA TANKI



OEM / COMPARISON NO		LITER LİTRE	Ø	↔ L1 / L2			TYPE / TİP
81514010024 81514010032 81514010062 81514010084 81514010150 82514015004	15,5 bar	25	246 mm	590 / 300 mm	10 kg	M22x1,5	





MAN

99208AP

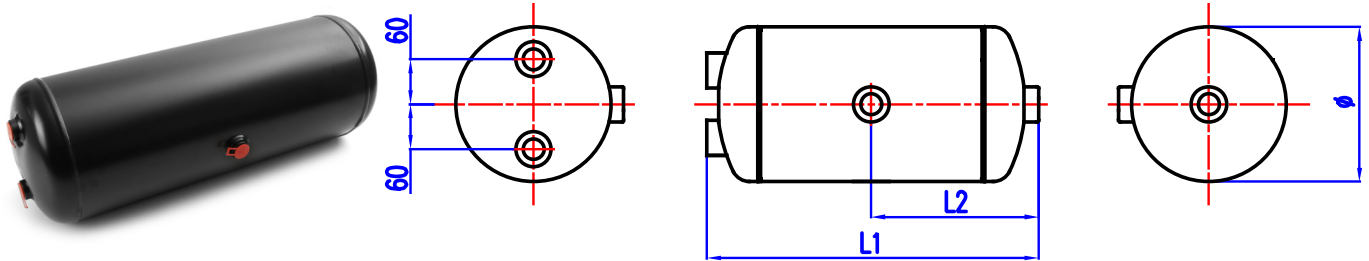
AIR TANK

HAVA TANKI



OEM / COMPARISON NO		LITER LİTRE	∅	↔ L1 / L2			TYPE / TİP
81514010133 81514010212 83514010512 83514015005 83514015012 83514015503 83514015507 83514016502	12,5 bar	30	246 mm	730 / 370 mm	12,4 kg	M22x1,5	





MAN

99212AP

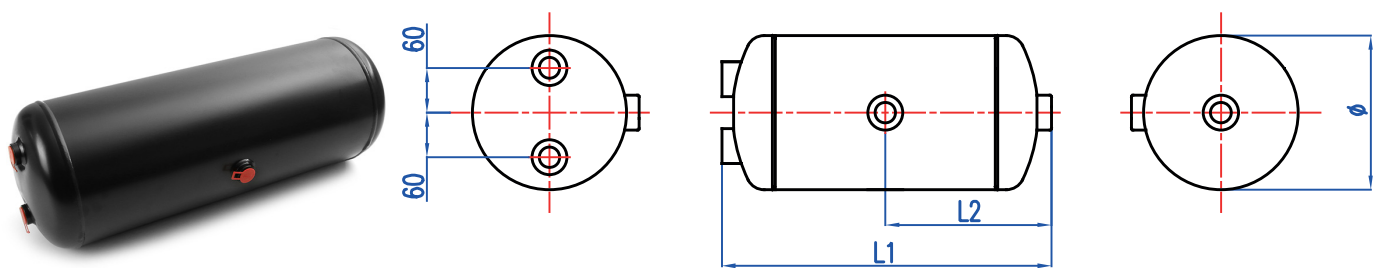
AIR TANK

HAVA TANKI



OEM / COMPARISON NO		LITER LİTRE	∅	↔ L1 / L2			TYPE / TİP
81514010142	15,5 bar	40	246 mm	927 / 468 mm	15,4 kg	M22x1,5	





MAN

99250AP

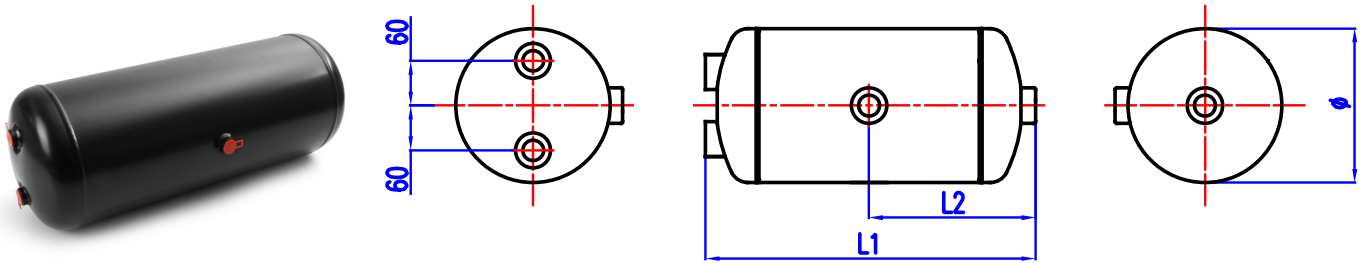
AIR TANK

HAVA TANKI



OEM / COMPARISON NO		LITER LITRE	∅	↔ L1 / L2			TYPE / TİP
81514010019 81514010145	15,5 bar	40	276 mm	760 / 385 mm	14,5 kg	M22x1,5	





MAN

99273AP

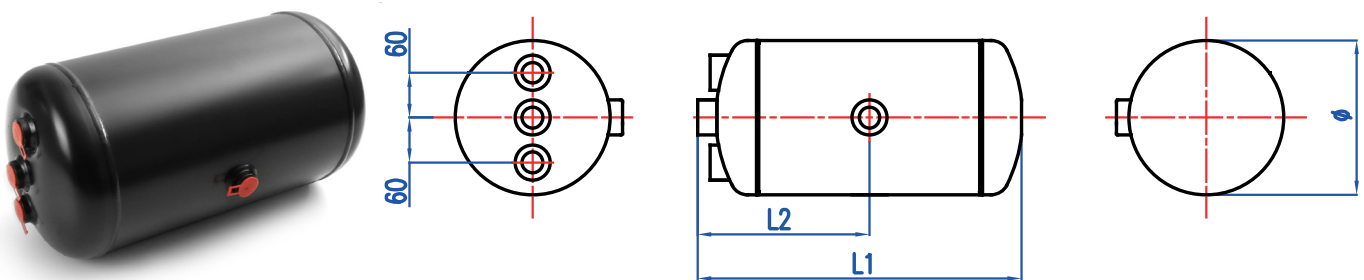
AIR TANK

HAVA TANKI



OEM / COMPARISON NO		LITER LITRE	∅	↔ L1 / L2			TYPE / TİP
81514010228 81514010238 81514010257 81514016029	12,5 bar	20	310 mm	324 / 169 mm	8,1 kg	M22x1,5	





MAN

99275AP

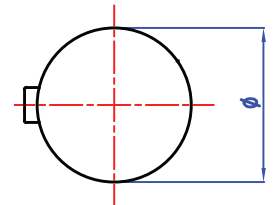
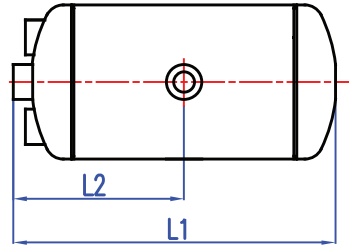
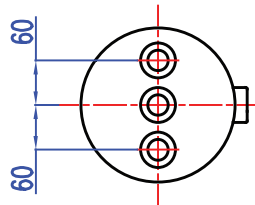
AIR TANK

HAVA TANKI



OEM / COMPARISON NO		LITER LİTRE	Ø	↔ L1 / L2			TYPE / TİP
81514010180 81514010204 81514010239 81514010249 81514010253 81514016013	12,5 bar	30	310 mm	462 / 238 mm	10,8 kg	M22x1,5	





MAN

99277AP

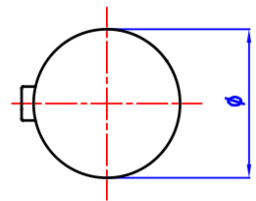
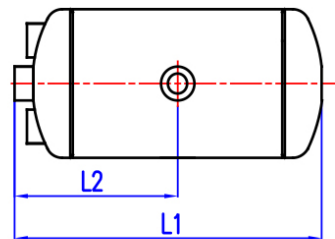
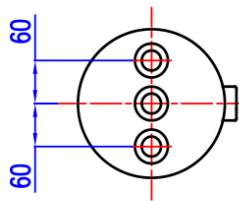
AIR TANK

HAVA TANKI



OEM / COMPARISON NO		LITER LİTRE	Ø	↔ L1 / L2			TYPE / TİP
81514010240 81514016014	12,5 bar	35	310 mm	529 / 272 mm	12 kg	M22x1,5	





MAN

99278AP

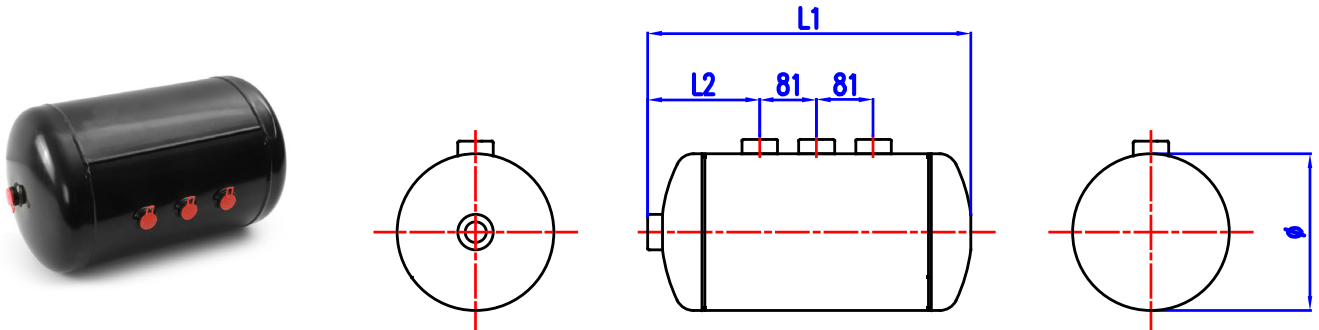
AIR TANK

HAVA TANKI



OEM / COMPARISON NO		LITER LITRE	Ø	↔ L1 / L2			TYPE / TİP
81514010259 81514016038 81514016156	12,5 bar	35	310 mm	529 / 190 mm	12 kg	M22x1,5	



MAN

99280AP

AIR TANK

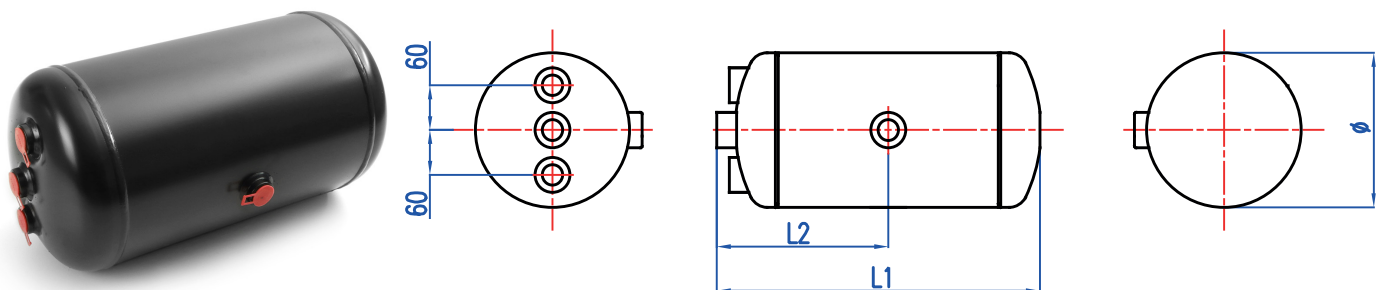
HAVA TANKI

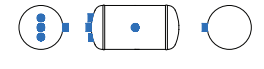

OEM / COMPARISON NO		LITER LITRE	Ø	↔ L1 / L2			TYPE / TİP
81514010182 81514010206 81514010241 81514016015	12,5 bar	40	310 mm	605 / 310 mm	13,5 kg	M22x1,5	



MAN

99290AP

AIR TANK

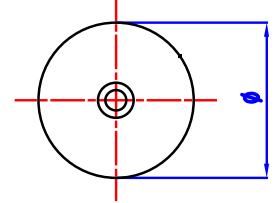
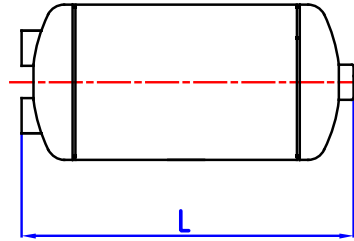
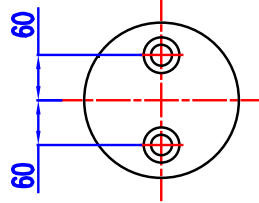
HAVA TANKI

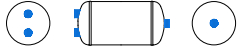

OEM / COMPARISON NO		LITER LİTRE	Ø	↔ L1 / L2			TYPE / TİP
81514010232 81514010233 81514010242 81514016033	12,5 bar	30	396 mm	345 mm	13,2 kg	M22x1,5	





MAN

99293AP

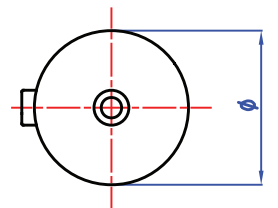
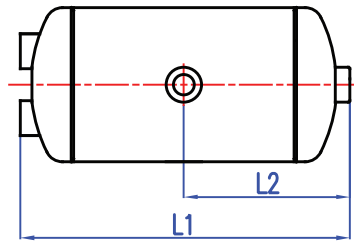
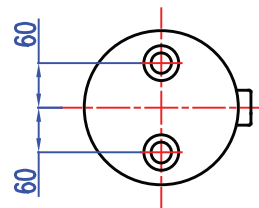
AIR TANK

HAVA TANKI



OEM / COMPARISON NO		LITER LİTRE	Ø	↔ L1 / L2			TYPE / TİP
88514016219	12,5 bar	60	396 mm	580 / 295 mm	20,1 kg	M22x1,5	



MERCEDES BENZ

99116AP

AIR TANK

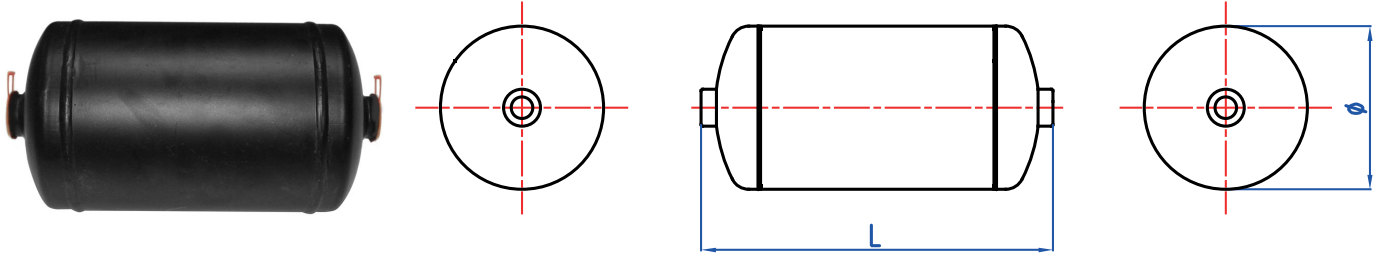
HAVA TANKI

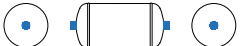

OEM / COMPARISON NO		LITER LİTRE	Ø	↔ L			TYPE / TİP
0044320501 0054323001 0064323401	15,5 bar	4	144 mm	321 mm	3,4 kg	M22x1,5	





MERCEDES BENZ

99117AP

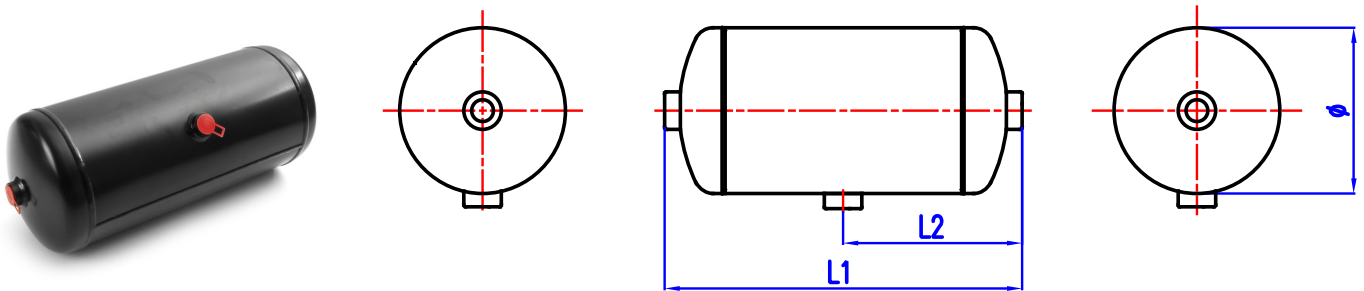
AIR TANK

HAVA TANKI



OEM / COMPARISON NO		LITER LİTRE	Ø	↔ L1 / L2			TYPE / TİP
0054323101 0064323501 0044320601	15,5 bar	5,4	144 mm	412 / 206 mm	4,3 kg	M22x1,5	





MERCEDES BENZ

99118AP

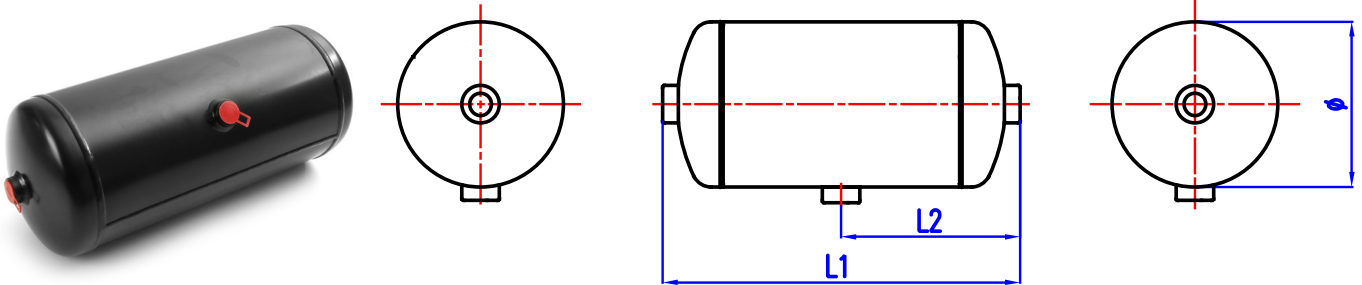
AIR TANK

HAVA TANKI



OEM / COMPARISON NO		LITER LİTRE	∅	↔ L1 / L2			TYPE / TİP
0034320601 0054322001	15,5 bar	6	144 mm	453 / 227 mm	4,7 kg	M22x1,5	





MERCEDES BENZ

99145AP

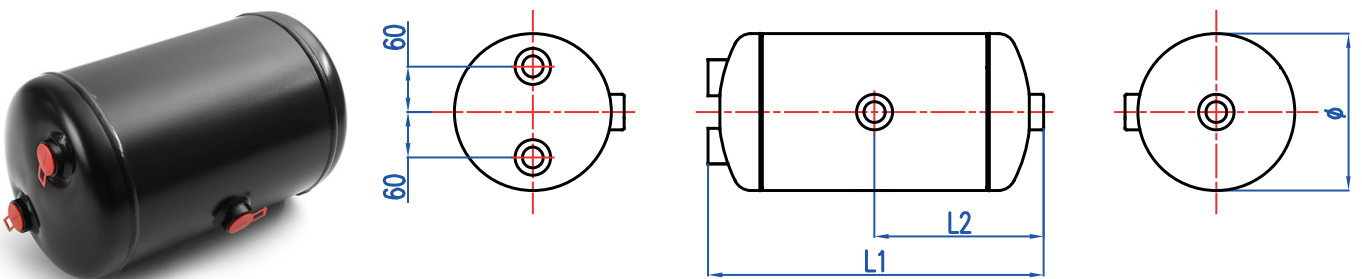
AIR TANK

HAVA TANKI



OEM / COMPARISON NO		LITER LİTRE	∅	↔ L1 / L2			TYPE / TİP
0004323101	15,5 bar	10	206 mm	368 / 189 mm	5,6 kg	M22x1,5	



MERCEDES BENZ

99146AP

AIR TANK

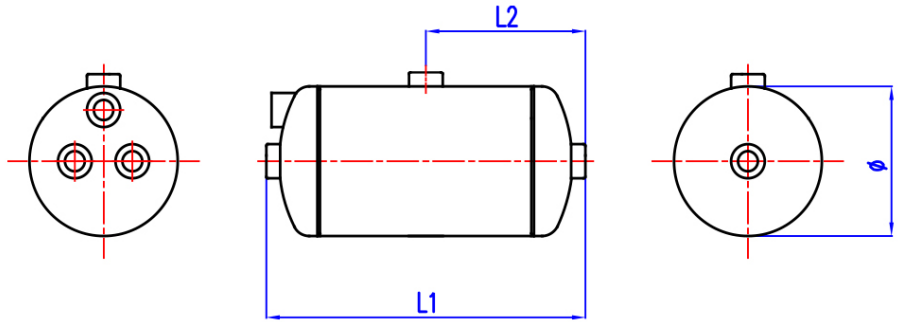
HAVA TANKI

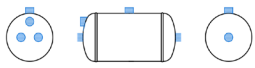

OEM / COMPARISON NO	 19 bar	LITER LİTRE	Ø	↔ L1 / L2	 5,8 kg	 M22x1,5	TYPE / TİP
0004329001 0024328201 0024328401		10	206 mm	360 / 185 mm			





MERCEDES BENZ

99150AP

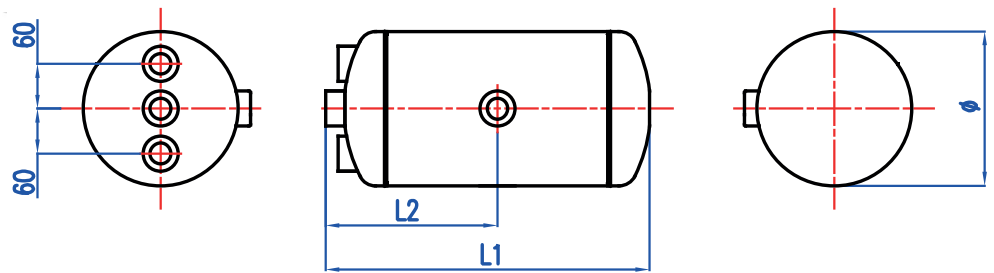
AIR TANK

HAVA TANKI



OEM / COMPARISON NO	 15,5 bar	LITER LİTRE	Ø	↔ L1 / L2	 5,9 kg	 M22x1,5	TYPE / TİP
0044320801 0054323301 0064323701		10	206 mm	366 / 190 mm			





MERCEDES BENZ

99151AP

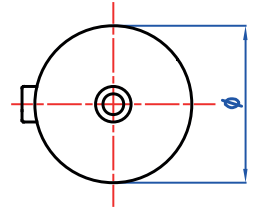
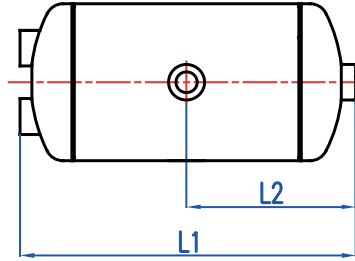
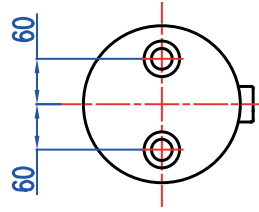
AIR TANK

HAVA TANKI



OEM / COMPARISON NO		LITER LİTRE	Ø	↔ L1 / L2			TYPE / TİP
0034320801 0074321101	15,5 bar	10	206 mm	370 / 190 mm	5,9 kg	M22x1,5	



MERCEDES BENZ

99164AP

AIR TANK

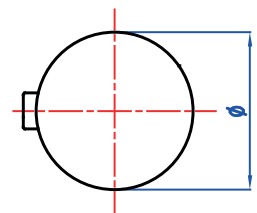
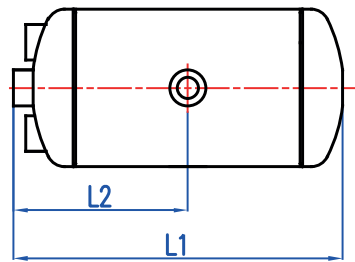
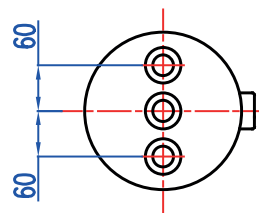
HAVA TANKI

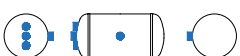

OEM / COMPARISON NO		LITER LİTRE	Ø	↔ L1 / L2			TYPE / TİP
0054324201 0064323801	15,5 bar	20	206 mm	677 / 345 mm	9,9 kg	M22x1,5	





MERCEDES BENZ

99167AP

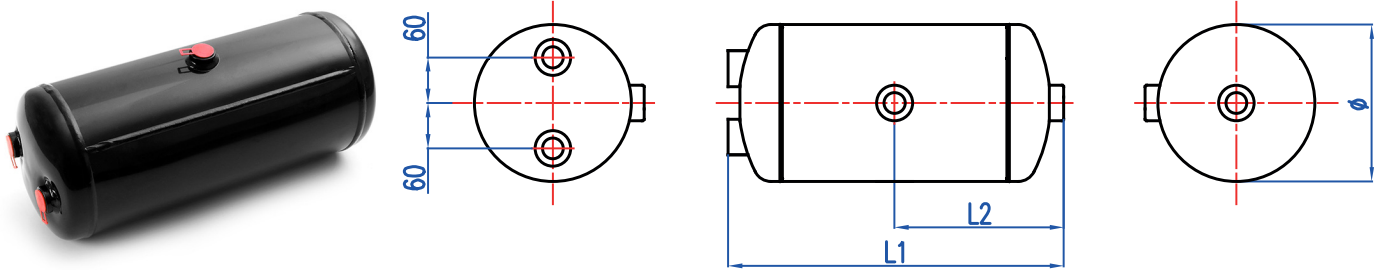
AIR TANK

HAVA TANKI



OEM / COMPARISON NO		LITER LITRE	Ø	↔ L1 / L2			TYPE / TİP
0004322001 0034321101 0064329801	15,5 bar	20	206 mm	692 / 351 mm	9,9 kg	M22x1,5	





MERCEDES BENZ

99171AP

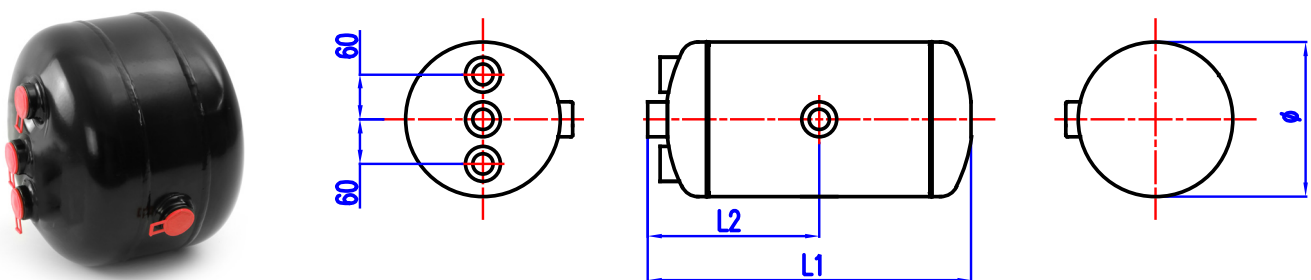
AIR TANK

HAVA TANKI



OEM / COMPARISON NO		LITER LITRE	Ø	↔ L1 / L2			TYPE / TİP
0044320701 0054323201 0064324001	15,5 bar	7,5	246 mm	228 / 121 mm	4,9 kg	M22x1,5	



MERCEDES BENZ

99173AP

AIR TANK

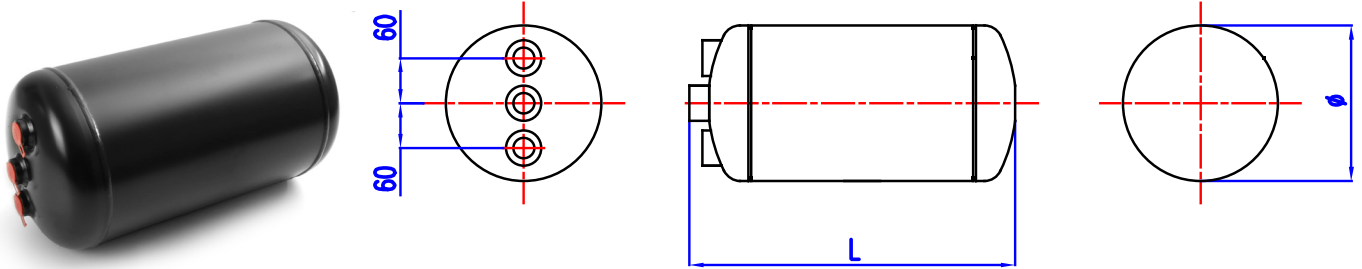
HAVA TANKI

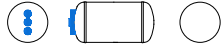

OEM / COMPARISON NO		LITER LITRE	Ø	↔ L1 / L2			TYPE / TİP
0034324101 0064328001 0064324201	15,5 bar	10	246 mm	277 mm	5,5 kg	M22x1,5	





MERCEDES BENZ

99180AP

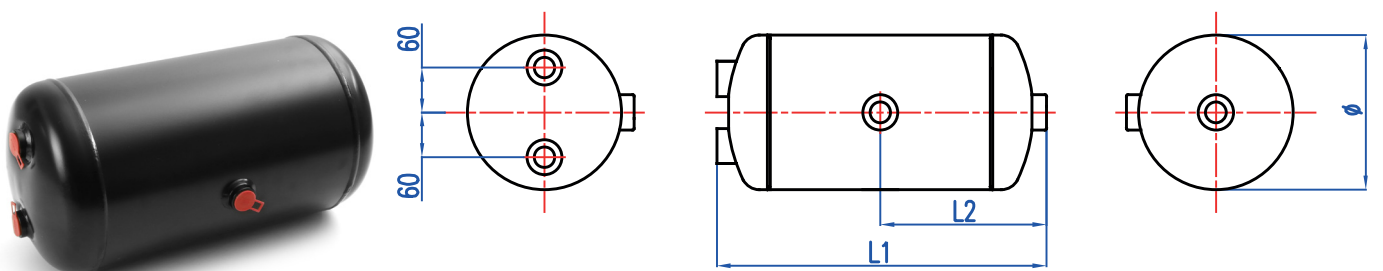
AIR TANK

HAVA TANKI



OEM / COMPARISON NO		LITER LITRE	Ø	↔ L1 / L2			TYPE / TİP
0004323201 0004324301	15,5 bar	20	246 mm	495 / 252 mm	8,9 kg	M22x1,5	





MERCEDES BENZ

99181AP

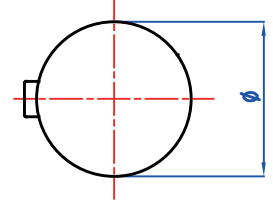
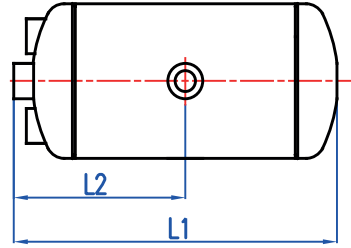
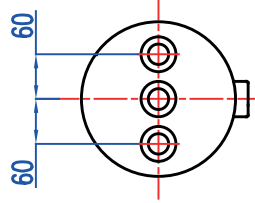
AIR TANK

HAVA TANKI



OEM / COMPARISON NO		LITER LİTRE	Ø	↔ L1 / L2			TYPE / TİP
0044321901 0054323401 0064324301	15,5 bar	20	246 mm	497 / 255 mm	9 kg	M22x1,5	





MERCEDES BENZ

99186AP

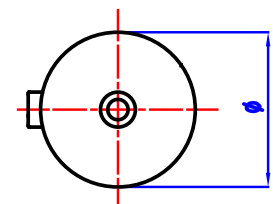
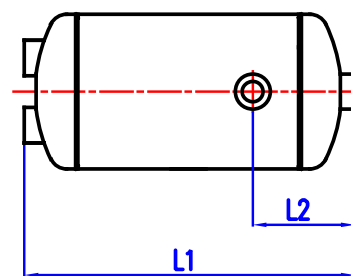
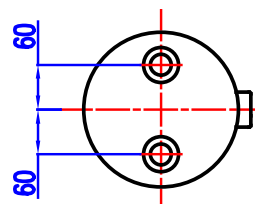
AIR TANK

HAVA TANKI



OEM / COMPARISON NO		LITER LİTRE	Ø	↔ L1 / L2			TYPE / TİP
0004324801 0004325101 0014327501 0024320001 0034321201 0034321301	12,5 bar	20	246 mm	500 / 128 mm	8,9 kg	M22x1,5	





MERCEDES BENZ

99195AP

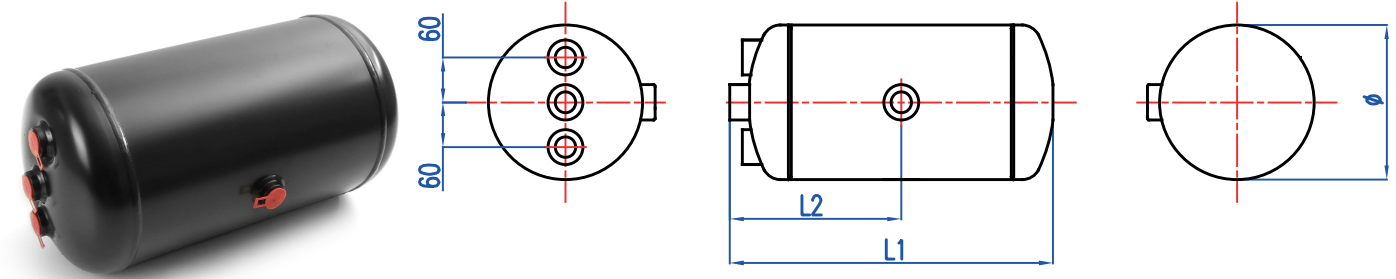
AIR TANK

HAVA TANKI



OEM / COMPARISON NO		LITER LİTRE	Ø	↔ L1 / L2			TYPE / TİP
0044324201 0054323801 0064324401	15,5 bar	25	246 mm	605 / 310 mm	11,4 kg	M22x1,5	





MERCEDES BENZ

99201AP

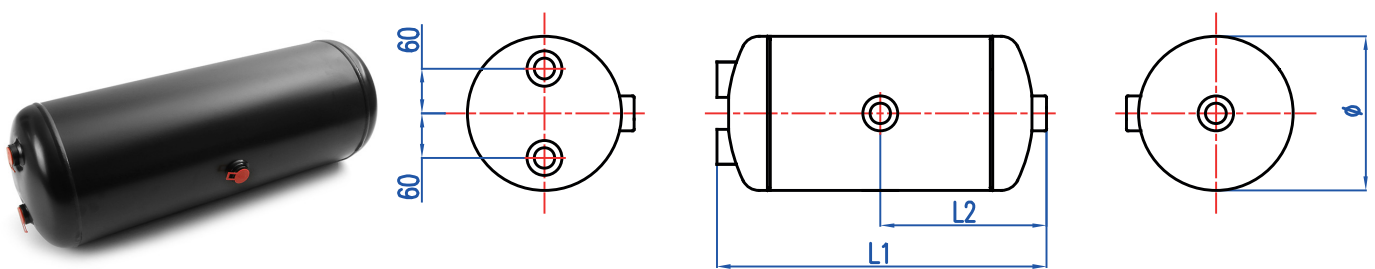
AIR TANK

HAVA TANKI



OEM / COMPARISON NO		LITER LİTRE	Ø	↔ L1 / L2			TYPE / TİP
0004322601 0004322801 0014326901 0034321801	15,5 bar	30	246 mm	709 / 359 mm	12 kg	M22x1,5	





MERCEDES BENZ

99203AP

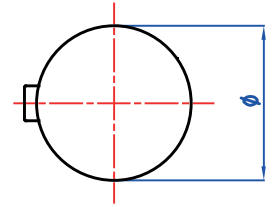
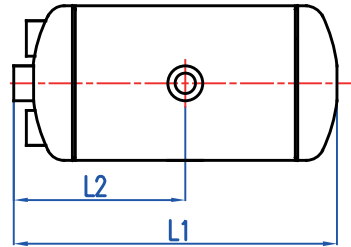
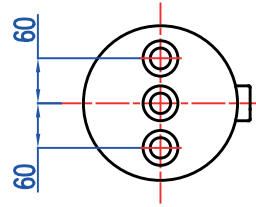
AIR TANK

HAVA TANKI



OEM / COMPARISON NO		LITER LITRE	Ø	↔ L1 / L2			TYPE / TİP
0034323201 0054322301 0064324501	15,5 bar	30	246 mm	715 / 365 mm	12,3 kg	M22x1,5	





MERCEDES BENZ

99209AP

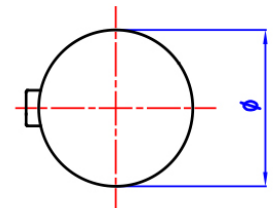
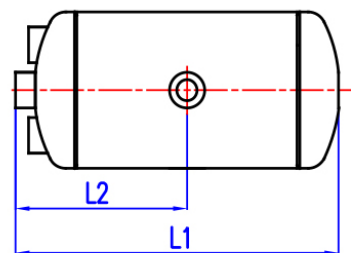
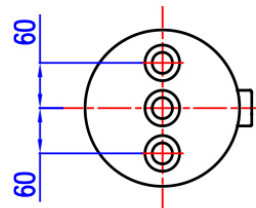
AIR TANK

HAVA TANKI



OEM / COMPARISON NO		LITER LITRE	Ø	↔ L1 / L2			TYPE / TİP
0054323501 0064324601 3754323901	15,5 bar	35	246 mm	715 / 365 mm	12,3 kg	M22x1,5	





MERCEDES BENZ

99212AP

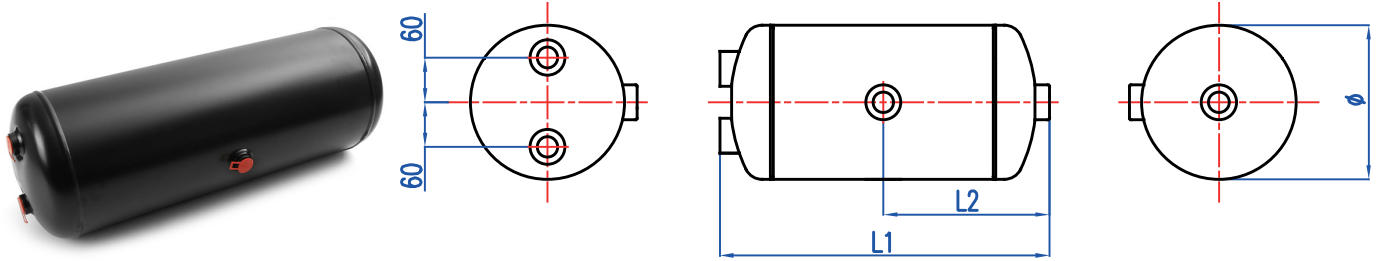
AIR TANK

HAVA TANKI



OEM / COMPARISON NO		LITER LİTRE	Ø	↔ L1 / L2			TYPE / TİP
0004322101 0034322301	15,5 bar	40	246 mm	927 / 468 mm	15,4 kg	M22x1,5	





MERCEDES BENZ

99213AP

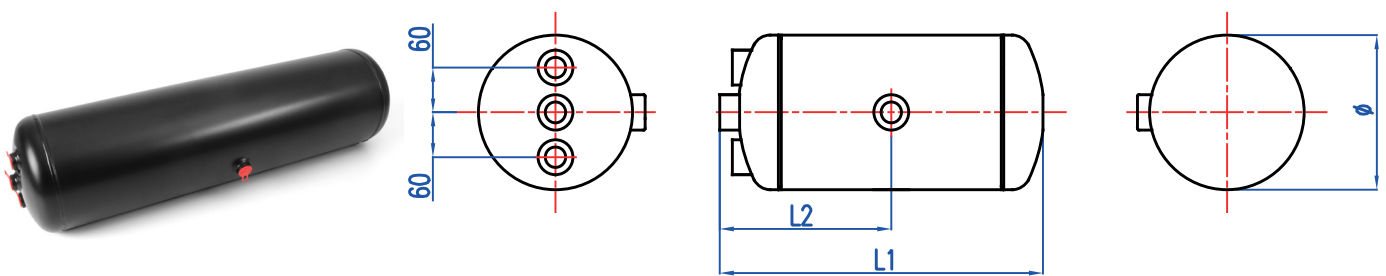
AIR TANK

HAVA TANKI



OEM / COMPARISON NO		LITER LİTRE	Ø	↔ L1 / L2			TYPE / TİP
0044320001 0054322901 0064324701	15,5 bar	40	246 mm	932 / 473 mm	15,5 kg	M22x1,5	



MERCEDES BENZ

99216AP

AIR TANK

HAVA TANKI



OEM / COMPARISON NO	 15,5 bar	LITER LITRE	Ø	↔ L1 / L2	 22,2 kg	 M22x1,5	TYPE / TİP
0044326801 0054324301 0064323901		25	206 mm	1369 / 691 mm			



MERCEDES BENZ

99217AP

AIR TANK

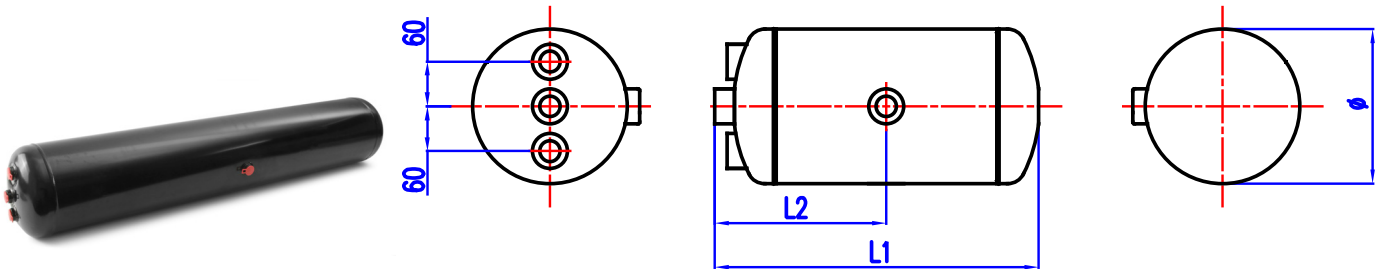
HAVA TANKI

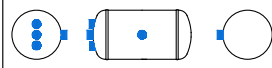

OEM / COMPARISON NO	 15,5 bar	LITER LITRE	Ø	↔ L1 / L2	 22,2 kg	 M22x1,5	TYPE / TİP
0054323701 0064324901		60	246 mm	1369 / 691 mm			





MERCEDES BENZ

99225AP

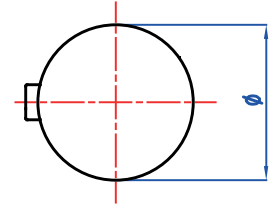
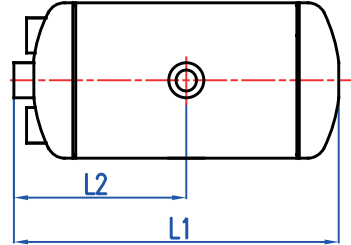
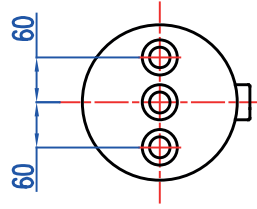
AIR TANK

HAVA TANKI



OEM / COMPARISON NO		LITER LİTRE	Ø	↔ L1 / L2			TYPE / TİP
0044323101 0054323601 0064325201	15,5 bar	20	276 mm	411 / 254 mm	8,5 kg	M22x1,5	





MERCEDES BENZ

99229AP

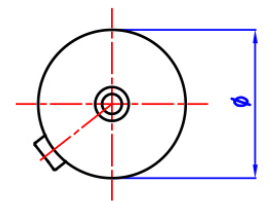
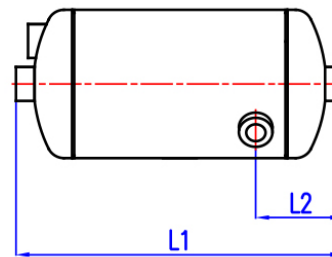
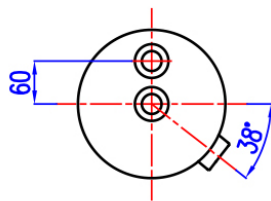
AIR TANK

HAVA TANKI



OEM / COMPARISON NO		LITER LİTRE	Ø	↔ L1 / L2			TYPE / TİP
0014326101 0024323801 0034321601	15,5 bar	20	276 mm	488 / 251 mm	10 kg	M22x1,5	





MERCEDES BENZ

99233AP

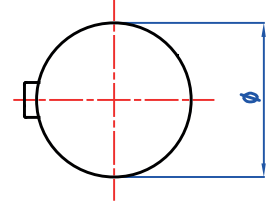
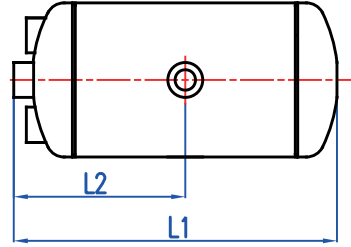
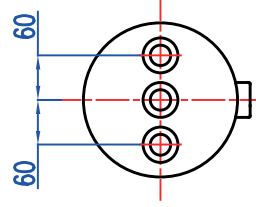
AIR TANK

HAVA TANKI



OEM / COMPARISON NO		LITER LİTRE	Ø	↔ L1 / L2			TYPE / TİP
0034329401 0054322601 0064325301	15,5 bar	25	276 mm	488 / 251 mm	10 kg	M22x1,5	





MERCEDES BENZ

99240AP

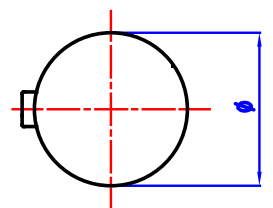
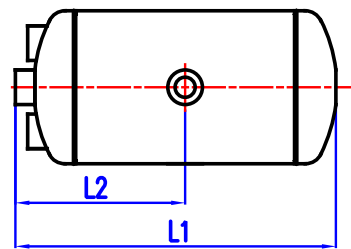
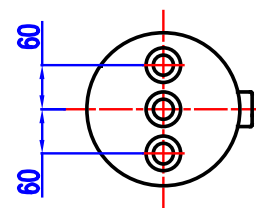
AIR TANK

HAVA TANKI



OEM / COMPARISON NO		LITER LİTRE	Ø	↔ L1 / L2			TYPE / TİP
0044324301 0054323901 0064325501	15,5 bar	30	276 mm	589 / 302 mm	11,7 kg	M22x1,5	





MERCEDES BENZ

99242AP

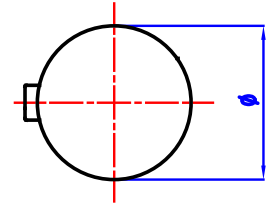
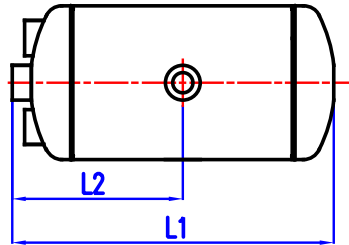
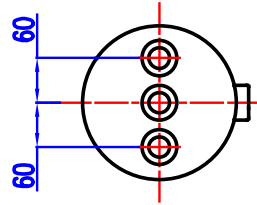
AIR TANK

HAVA TANKI



OEM / COMPARISON NO		LITER LİTRE	Ø	↔ L1 / L2			TYPE / TİP
0004328801 0014320201 0024320801 0034322001 0034322101 0054322201 0064325401	15,5 bar	30	276 mm	580 / 297 mm	10,7 kg	M22x1,5	





MERCEDES BENZ

99243AP

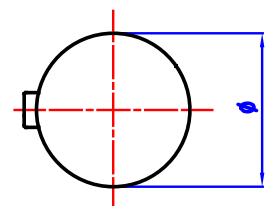
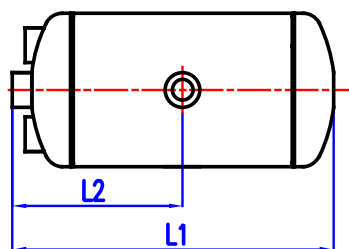
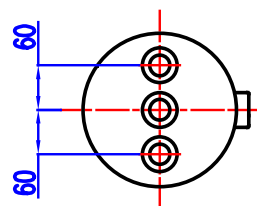
AIR TANK

HAVA TANKI



OEM / COMPARISON NO		LITER LİTRE	Ø	↔ L1 / L2			TYPE / TİP
0034329501 0054322701 0064325601	15,5 bar	35	276 mm	663 / 339 mm	12,9 kg	M22x1,5	





MERCEDES BENZ

99248AP

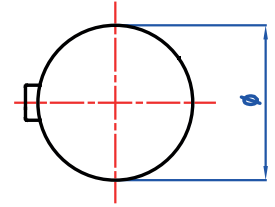
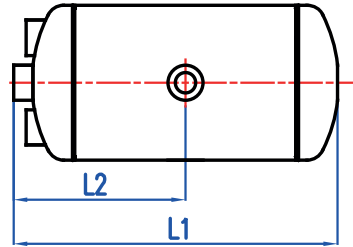
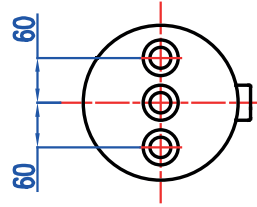
AIR TANK

HAVA TANKI



OEM / COMPARISON NO		LITER LİTRE	∅	↔ L1 / L2			TYPE / TİP
0034323901 0054322501 0064325701	15,5 bar	40	276 mm	758 / 386 mm	14,5 kg	M22x1,5	





MERCEDES BENZ

99254AP

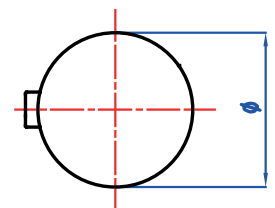
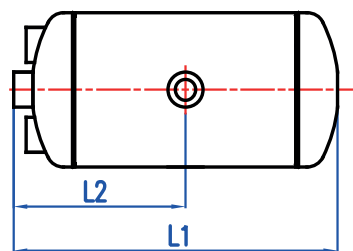
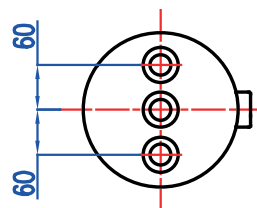
AIR TANK

HAVA TANKI



OEM / COMPARISON NO		LITER LİTRE	∅	↔ L1 / L2			TYPE / TİP
0034329901 0054322801 0064325801	15,5 bar	45	276 mm	844 / 429mm	16 kg	M22x1,5	





MERCEDES BENZ

99258AP

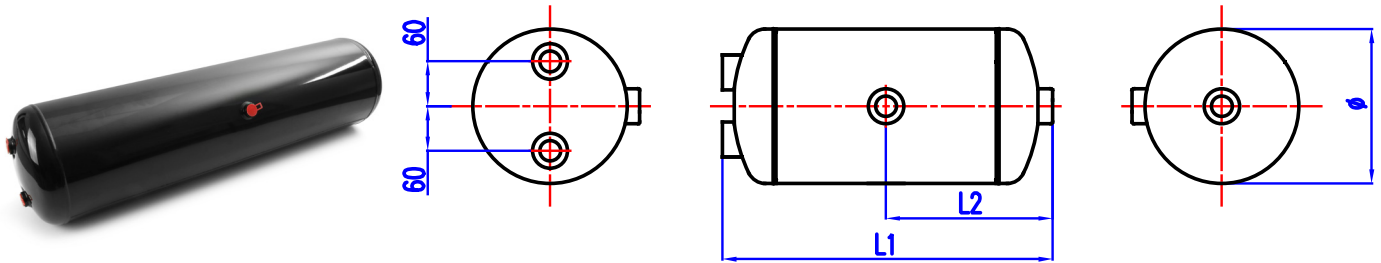
AIR TANK

HAVA TANKI



OEM / COMPARISON NO		LITER LITRE	Ø	↔ L1 / L2			TYPE / TİP
0034322701	15,5 bar	60	276 mm	1108 / 559 mm	20,5 kg	M22x1,5	





MERCEDES BENZ

99259AP

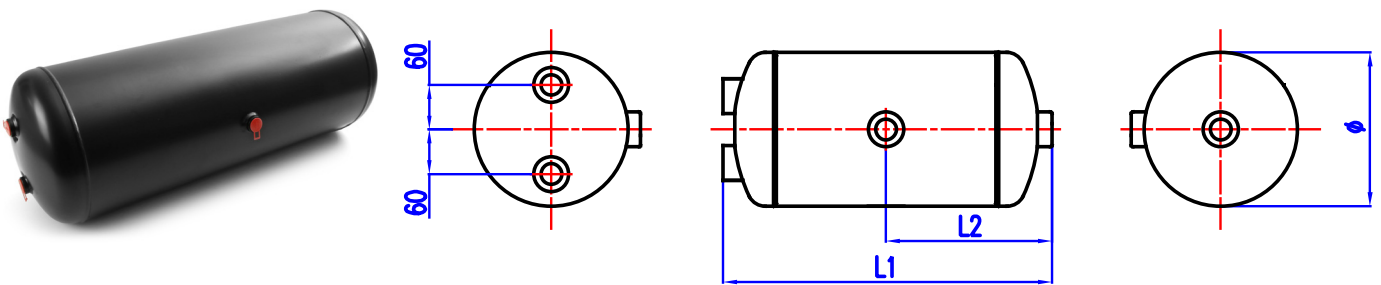
AIR TANK

HAVA TANKI



OEM / COMPARISON NO		LITER LITRE	Ø	↔ L1 / L2			TYPE / TİP
0004321101	12,5 bar	85	276 mm	1502 / 756 mm	27 kg	M22x1,5	





MERCEDES BENZ

99260AP

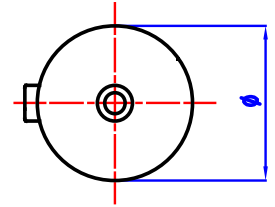
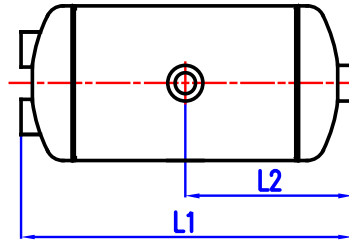
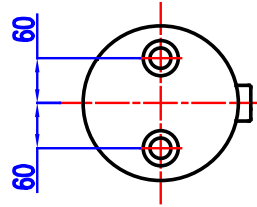
AIR TANK

HAVA TANKI



OEM / COMPARISON NO		LITER LITRE	Ø	↔ L1 / L2			TYPE / TİP
0004326501 0034321401	12,5 bar	20	276 mm	390 / 200 mm	8,2 kg	M22x1,5	





MERCEDES BENZ

99347AP

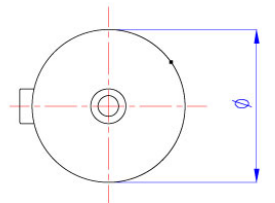
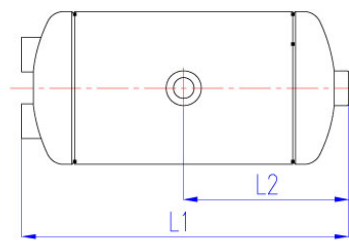
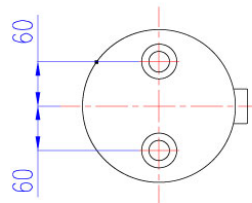
AIR TANK

HAVA TANKI



OEM / COMPARISON NO		LITER LITRE	Ø	↔ L1 / L2			TYPE / TİP
0034322001 0024320801 0014320201	15,5 bar	30	276 mm	583 / 296 mm	11,5 kg	M22x1,5	



MERCEDES BENZ

99381AP

AIR TANK

HAVA TANKI



OEM / COMPARISON NO		LITER LITRE	Ø	↔ L1 / L2			TYPE / TİP
0064324801	15,5 bar	50	246 mm	390 / 200 mm	8,2 kg	M22x1,5	





NEOPLAN

99201AP

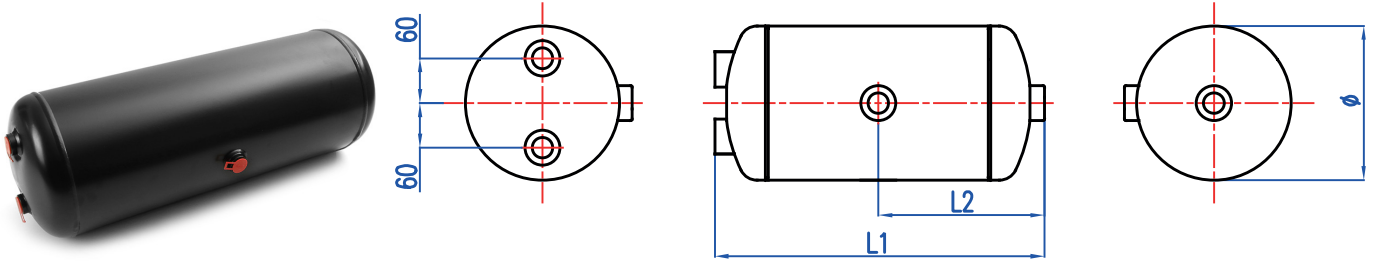
AIR TANK

HAVA TANKI



OEM / COMPARISON NO		LITER LITRE	Ø	↔ L1 / L2			TYPE / TİP
07030030	15,5 bar	30	246 mm	709 / 359 mm	12 kg	M22x1,5	





RENAULT

99119AP

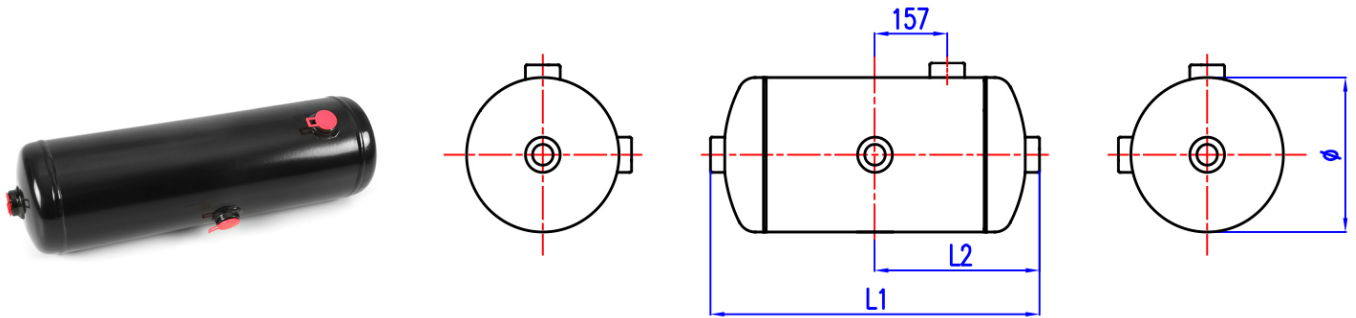
AIR TANK

HAVA TANKI



OEM / COMPARISON NO		LITER LİTRE	∅	↔ L1 / L2			TYPE / TİP
5010525415	13 bar	8	154 mm	539 / 262 mm	5,8 kg	M22x1,5	



RENAULT

99132AP

AIR TANK

HAVA TANKI



OEM / COMPARISON NO		LITER LİTRE	∅	↔ L1 / L2			TYPE / TİP
5010525437	13 bar	15	200 mm	539 / 282 mm	8,2 kg	M22x1,5	



RENAULT

99154AP

AIR TANK

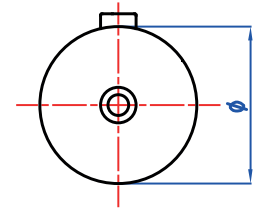
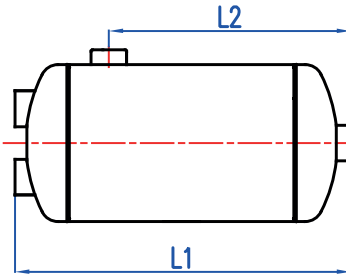
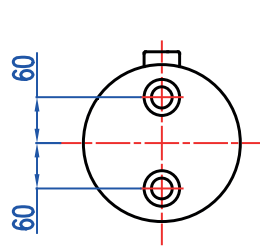
HAVA TANKI

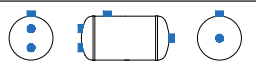

OEM / COMPARISON NO		LITER LITRE	∅	↔ L1 / L2			TYPE / TİP
7420579600	15 bar	15	206 mm	515 / 359 mm	7,7 kg	M22x1,5	





RENAULT

99160AP

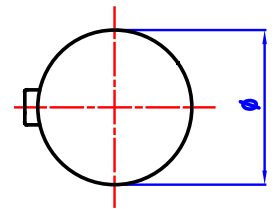
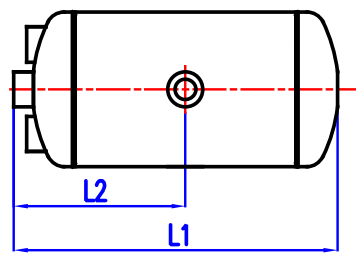
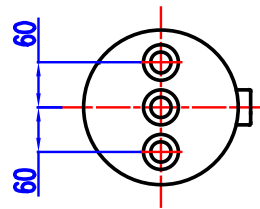
AIR TANK

HAVA TANKI



OEM / COMPARISON NO		LITER LITRE	∅	↔ L1 / L2			TYPE / TİP
7420904405	15 bar	15	206 mm	550 / 282 mm	8,2 kg	M22x1,5	





RENAULT

99177AP

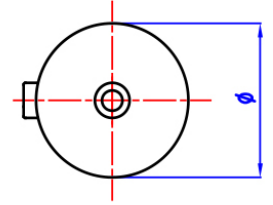
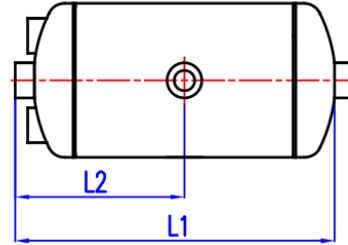
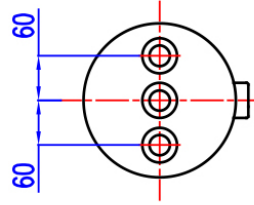
AIR TANK

HAVA TANKI



OEM / COMPARISON NO		LITER LITRE	Ø	↔ L1 / L2			TYPE / TİP
7421187782	15 bar	15	246 mm	385 / 301 mm	10,3 kg	M22x1,5	





RENAULT

99191AP

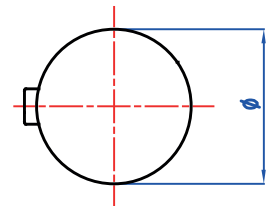
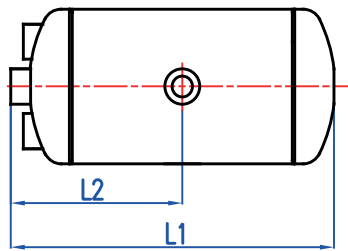
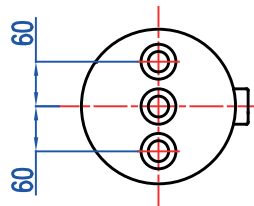
AIR TANK

HAVA TANKI



OEM / COMPARISON NO		LITER LITRE	Ø	↔ L1 / L2			TYPE / TİP
7420904407	15 bar	25	246 mm	588 / 301 mm	10,3 kg	M22x1,5	





RENAULT

99212AP

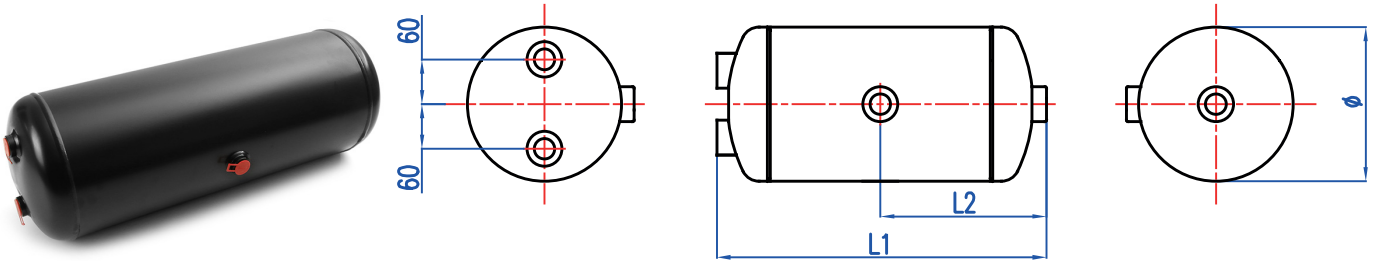
AIR TANK

HAVA TANKI



OEM / COMPARISON NO		LITER LİTRE	Ø	↔ L1 / L2			TYPE / TİP
0038437700 0074320101	15,5 bar	40	246 mm	927 / 468 mm	15,4 kg	M22x1,5	





RENAULT

99218AP

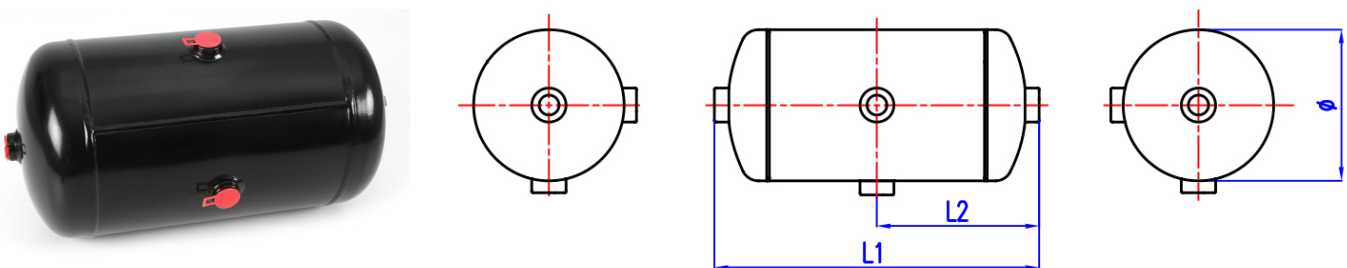
AIR TANK

HAVA TANKI



OEM / COMPARISON NO		LITER LİTRE	Ø	↔ L1 / L2			TYPE / TİP
5010525442	13 bar	20	250 mm	491 / 246 mm	8,9 kg	M22x1,5	





RENAULT

99219AP

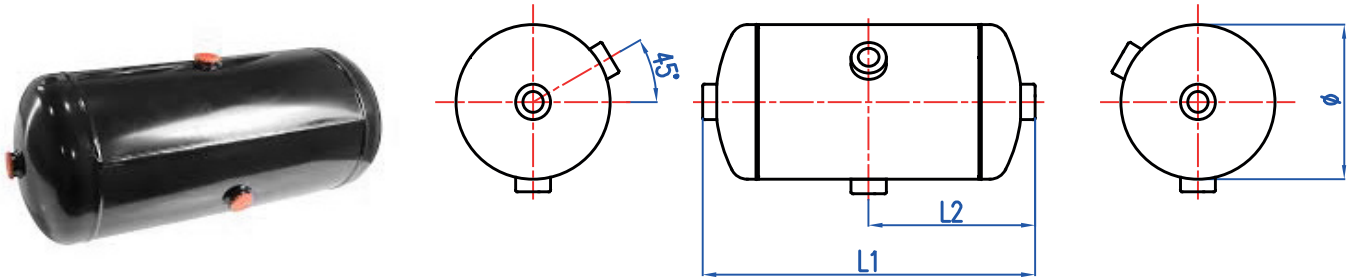
AIR TANK

HAVA TANKI



OEM / COMPARISON NO		LITER LİTRE	Ø	↔ L1 / L2			TYPE / TİP
5010525445	13 bar	25	250 mm	597 / 299 mm	10,2 kg	M22x1,5	





RENAULT

99220AP

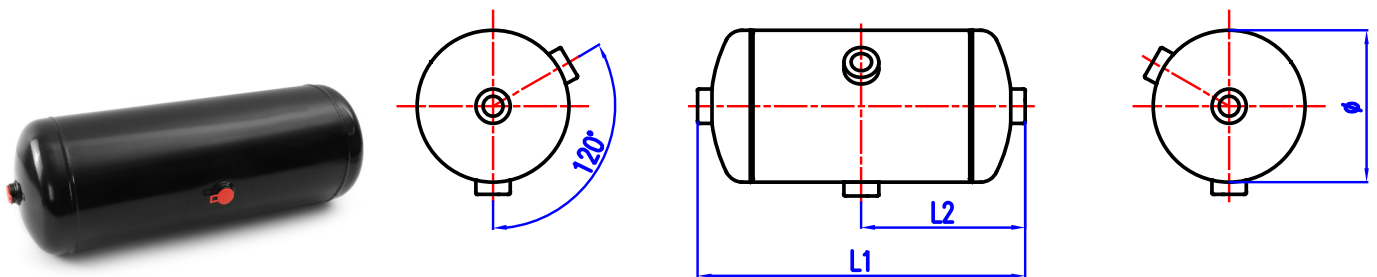
AIR TANK

HAVA TANKI



OEM / COMPARISON NO		LITER LİTRE	Ø	↔ L1 / L2			TYPE / TİP
5010525447	13 bar	30	250 mm	705 / 353 mm	12,2 kg	M22x1,5	



RENAULT

99221AP

AIR TANK

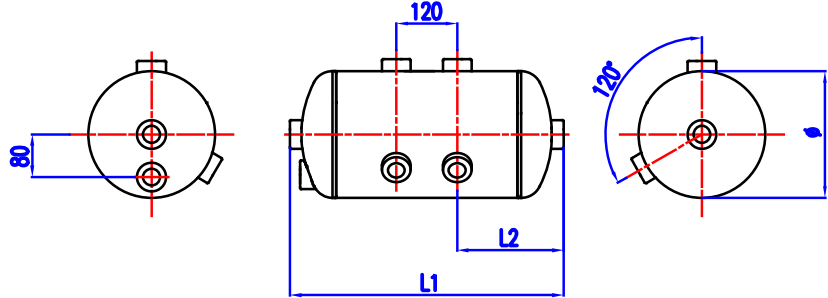
HAVA TANKI

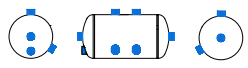

OEM / COMPARISON NO		LITER LİTRE	∅	↔ L1 / L2			TYPE / TİP
5010525446	13 bar	30	250 mm	705/293 mm	12,5 kg	M22x1,5	





RENAULT

99227AP

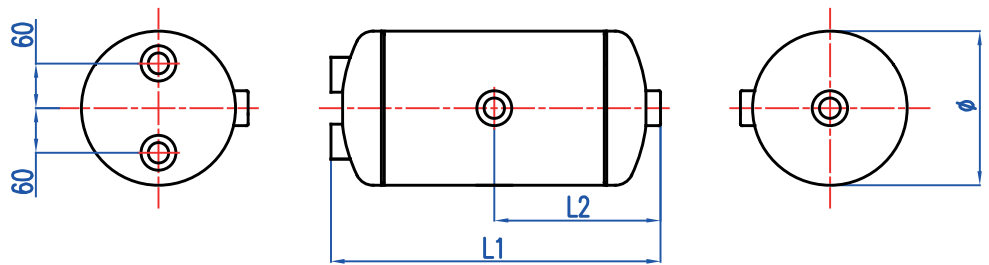
AIR TANK

HAVA TANKI



OEM / COMPARISON NO		LITER LİTRE	∅	↔ L1 / L2			TYPE / TİP
5021170381	15,5 bar	20	276 mm	412 / 211 mm	8,6 kg	M22x1,5	





RENAULT

99231AP

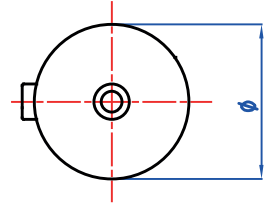
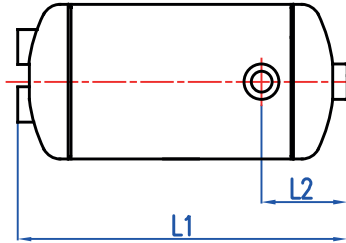
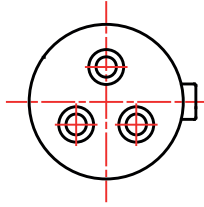
AIR TANK

HAVA TANKI



OEM / COMPARISON NO		LITER LİTRE	Ø	↔ L1 / L2			TYPE / TİP
7420579604	15 bar	25	276 mm	490 / 121 mm	10 kg	M22x1,5	





RENAULT

99235AP

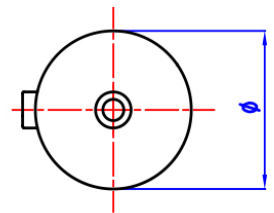
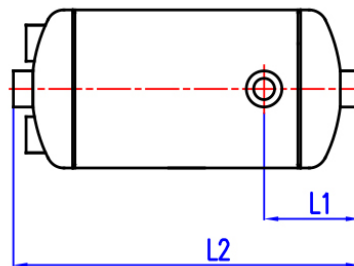
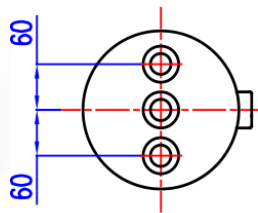
AIR TANK

HAVA TANKI



OEM / COMPARISON NO		LITER LİTRE	Ø	↔ L1 / L2			TYPE / TİP
7421187789	15 bar	25	276 mm	740 / 208 mm	14,4 kg	M22x1,5	



RENAULT

99244AP

AIR TANK

HAVA TANKI



OEM / COMPARISON NO	 15 bar	LITER LITRE	Ø	↔ L1 / L2	 14,4 kg	 M22x1,5	TYPE / TİP
7421187793	15 bar	38	276 mm	710 / 208 mm	14,4 kg	M22x1,5	





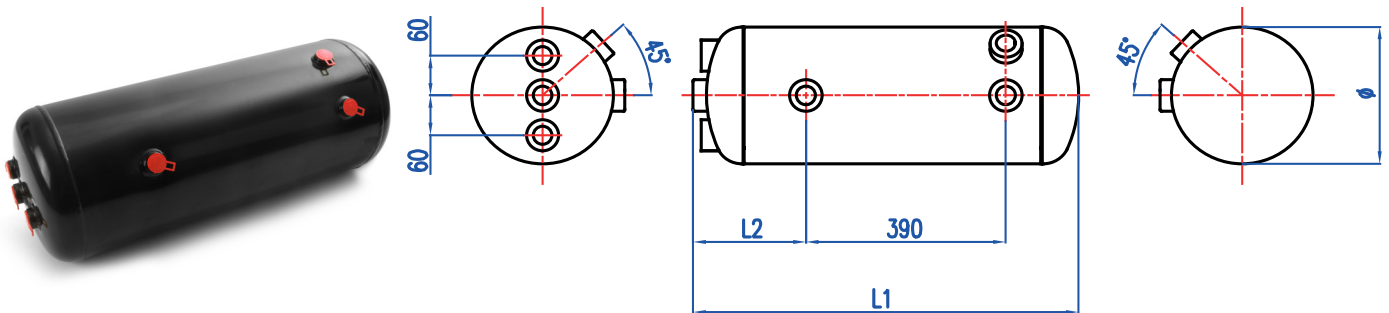

RENAULT

99247AP

AIR TANK

HAVA TANKI



OEM / COMPARISON NO	 15 bar	LITER LITRE	Ø	↔ L1 / L2	 14,4 kg	 M22x1,5	TYPE / TİP
5010525149	15 bar	40	276 mm	740 / 208 mm	14,4 kg	M22x1,5	  





RENAULT

99265AP

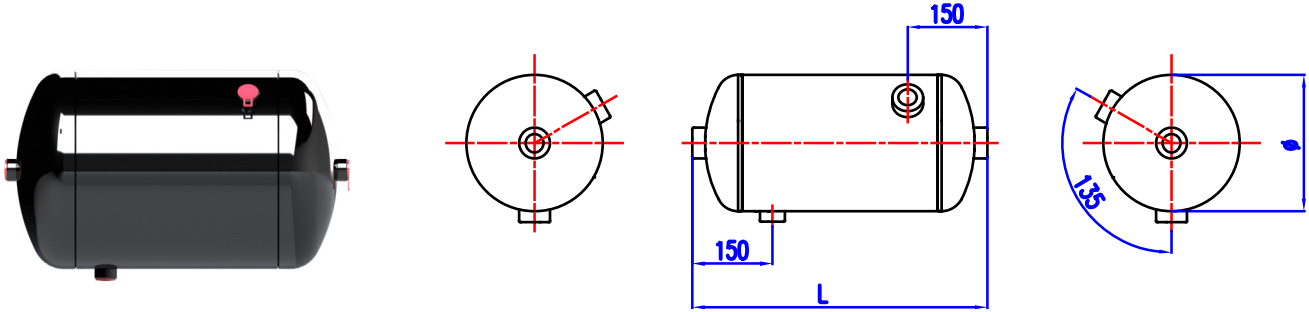
AIR TANK

HAVA TANKI



OEM / COMPARISON NO		LITER LİTRE	Ø	↔ L1 / L2			TYPE / TİP
5010525418	13 bar	30	300 mm	515 mm	11,1 kg	M22x1,5	





RENAULT

99272AP

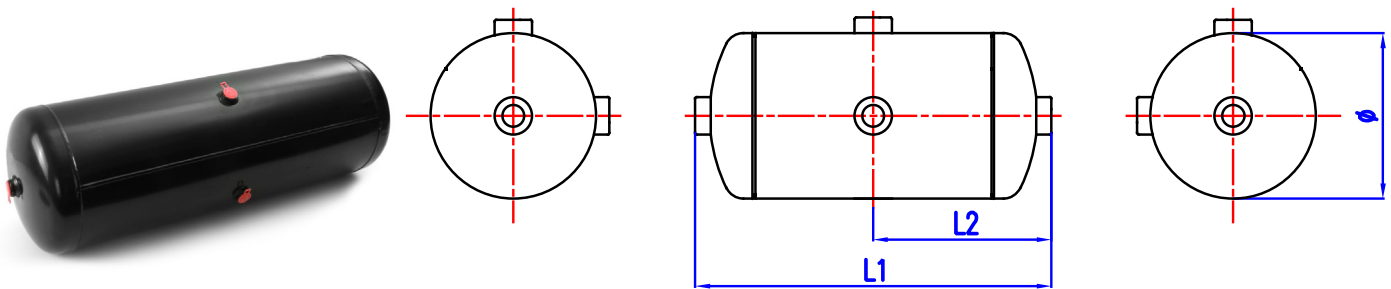
AIR TANK

HAVA TANKI



OEM / COMPARISON NO		LITER LİTRE	Ø	↔ L1 / L2			TYPE / TİP
1518200 5021170393	12,5 bar	60	300 mm	966 / 483 mm	19,5 kg	M22x1,5	



RENAULT

99287AP

AIR TANK

HAVA TANKI



OEM / COMPARISON NO	 13 bar	LITER LİTRE	Ø	↔ L1 / L2	 11,1 kg	 M22x1,5	TYPE / TİP
5010525419	13 bar	30	320 mm	464 mm	11,1 kg	M22x1,5	



RENAULT

99288AP

AIR TANK

HAVA TANKI



OEM / COMPARISON NO	 13 bar	LITER LİTRE	Ø	↔ L1 / L2	 11,1 kg	 M22x1,5	TYPE / TİP
5010525419	13 bar	40	320 mm	464 mm	11,1 kg	M22x1,5	





RENAULT

99291AP

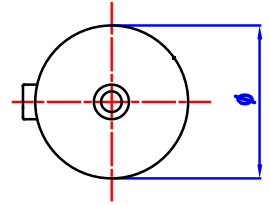
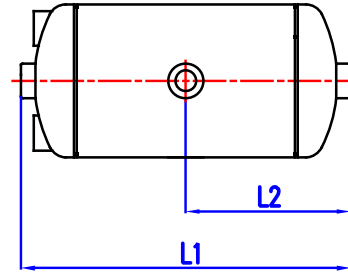
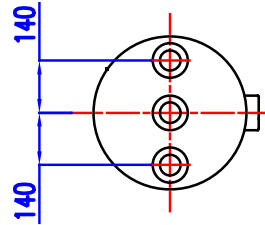
AIR TANK

HAVA TANKI



OEM / COMPARISON NO	 15 bar	LITER LITRE 39	Ø 396 mm	↔ L1 / L2 417 / 208 mm	 15,1 kg	 M22x1,5	TYPE / TİP 
7421187795	15 bar	39	396 mm	417 / 208 mm	15,1 kg	M22x1,5	





SAF

99167AP

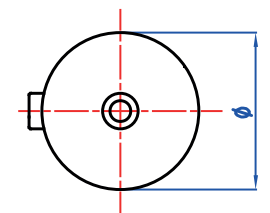
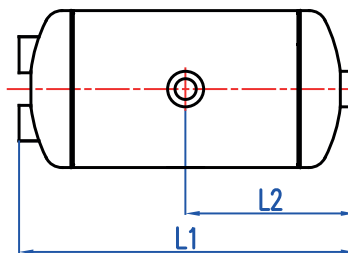
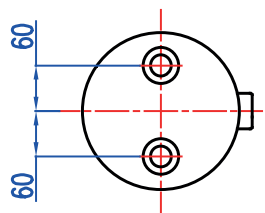
AIR TANK

HAVA TANKI



OEM / COMPARISON NO	 15,5 bar	LITER LITRE 20	Ø 206 mm	↔ L1 / L2 692 / 351 mm	 9,9 kg	 M22x1,5	TYPE / TİP 
4105000200	15,5 bar	20	206 mm	692 / 351 mm	9,9 kg	M22x1,5	



SCANIA

99120AP

AIR TANK

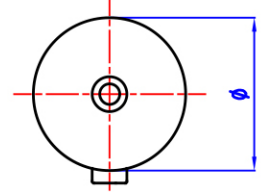
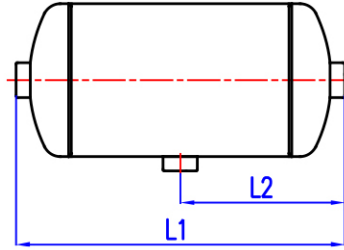
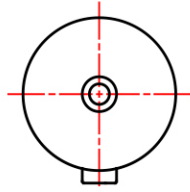
HAVA TANKI

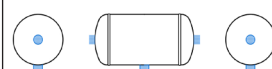

OEM / COMPARISON NO		LITER LITRE	Ø	↔ L1 / L2			TYPE / TİP
1887788	14,5 bar	3	154 mm	224 / 112 mm	2,7 kg	M22x1,5	



SCANIA

99128AP

AIR TANK

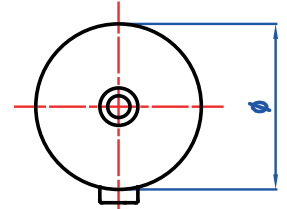
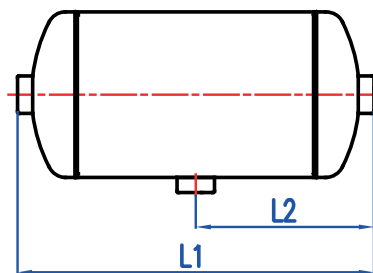
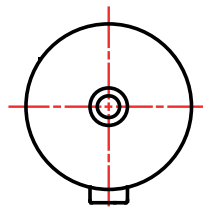
HAVA TANKI

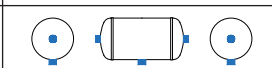

OEM / COMPARISON NO		LITER LITRE	Ø	↔ L1 / L2			TYPE / TİP
1360400 1383853	14,5 bar	7,4	154 mm	486 / 243 mm	5,2 kg	M22x1,5	





SCANIA

99135AP

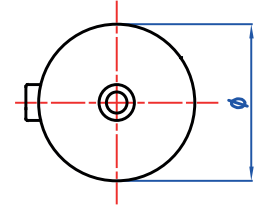
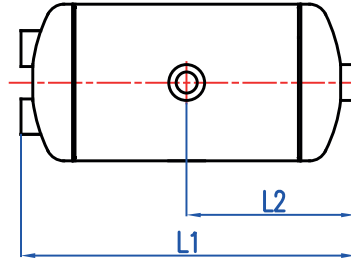
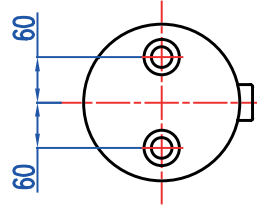
AIR TANK

HAVA TANKI



OEM / COMPARISON NO	 15,5 bar	LITER LITRE 6	∅ 206 mm	↔ L1 / L2 241 / 125 mm	 4,2 kg	 M22x1,5	TYPE / TIP 
9501100020	15,5 bar	6	206 mm	241 / 125 mm	4,2 kg	M22x1,5	





SCANIA

99153AP

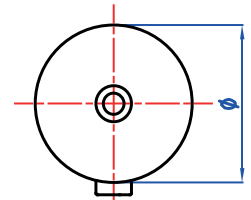
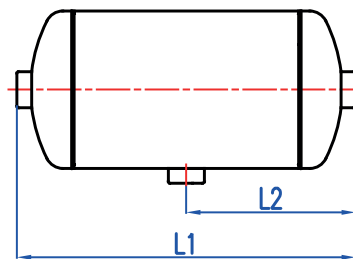
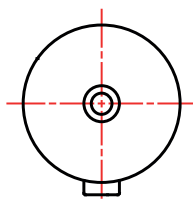
AIR TANK

HAVA TANKI



OEM / COMPARISON NO	 14,5 bar	LITER LITRE 15	∅ 206 mm	↔ L1 / L2 513 / 171 mm	 7,5 kg	 M22x1,5	TYPE / TIP 
1445452 1792544	14,5 bar	15	206 mm	513 / 171 mm	7,5 kg	M22x1,5	





SCANIA

99156AP

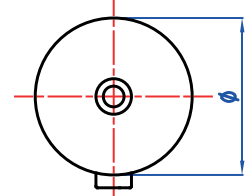
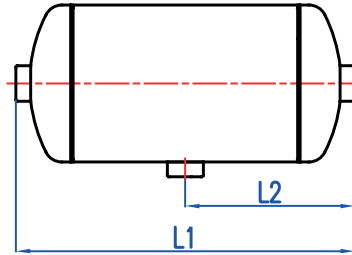
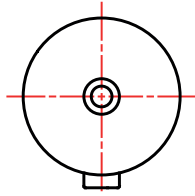
AIR TANK

HAVA TANKI



OEM / COMPARISON NO		LITER LITRE	∅	↔ L1 / L2			TYPE / TİP
1360401	14,5 bar	15	206 mm	526 / 263 mm	7,6 kg	M22x1,5	





SCANIA

99167AP

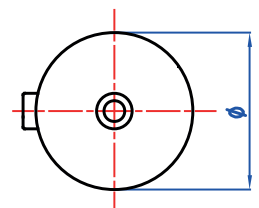
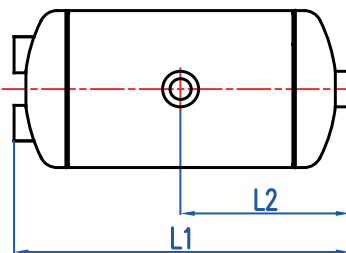
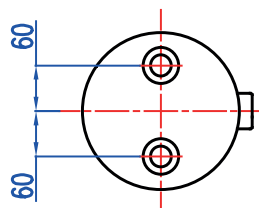
AIR TANK

HAVA TANKI



OEM / COMPARISON NO		LITER LITRE	∅	↔ L1 / L2			TYPE / TİP
1935524	15,5 bar	20	206 mm	692 / 351 mm	9,9 kg	M22x1,5	





SCANIA

99179AP

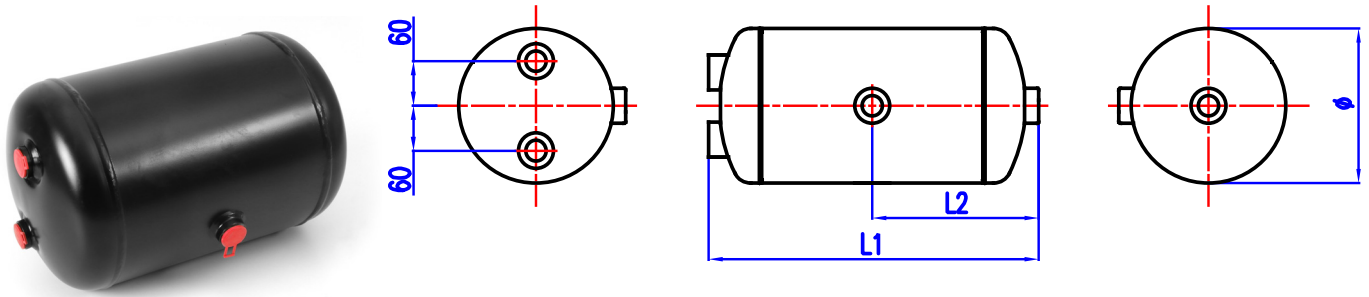
AIR TANK

HAVA TANKI



OEM / COMPARISON NO	 14 bar	LITER LITRE	∅	↔ L1 / L2	 7,2 kg	 M22x1,5	TYPE / TIP
1332534 1332535 1377865 370199 370201		16	246 mm	410 / 210 mm			



SCANIA

99200AP

AIR TANK

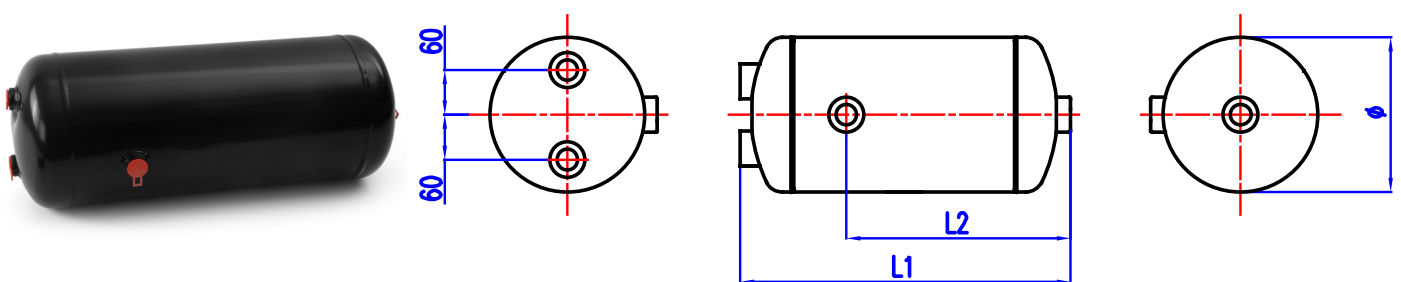
HAVA TANKI

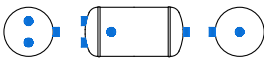

OEM / COMPARISON NO	 15,5 bar	LITER LITRE	∅	↔ L1 / L2	 11,1 kg	 M22x1,5	TYPE / TIP
1332532 1332533 1377864 370203 370204 370205		27	246 mm	645 / 464 mm			





SCANIA

99236AP

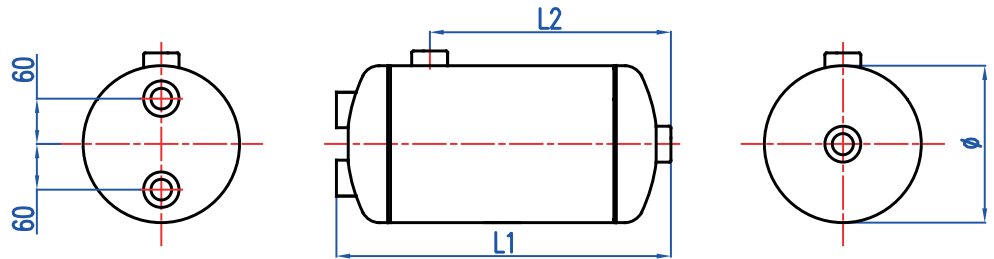
AIR TANK

HAVA TANKI



OEM / COMPARISON NO		LITER LITRE	Ø	↔ L1 / L2			TYPE / TİP
1357950 1383777 488217	14,5 bar	30	276 mm	568 / 388 mm	11,3 kg	M22x1,5	





SCANIA

99250AP

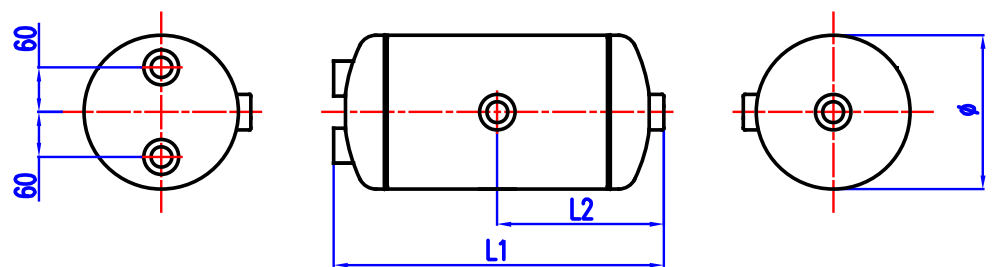
AIR TANK

HAVA TANKI



OEM / COMPARISON NO		LITER LITRE	Ø	↔ L1 / L2			TYPE / TİP
1935528	15,5 bar	40	276 mm	760 / 385 mm	14,5 kg	M22x1,5	

SCANIA

99276AP

AIR TANK

HAVA TANKI

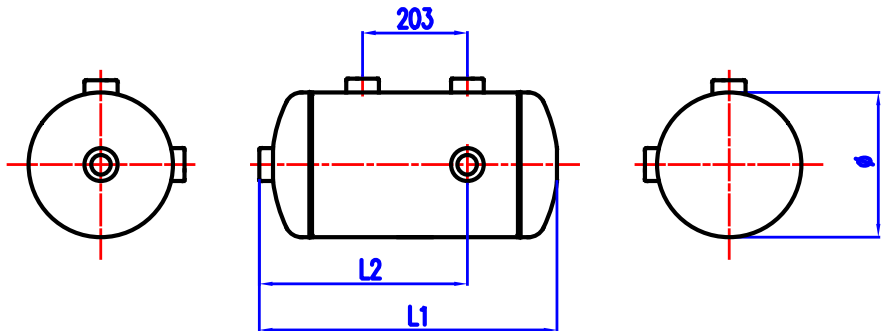

OEM / COMPARISON NO		LITER LITRE	∅	↔ L1 / L2			TYPE / TİP
1778889	14,5 bar	30	310 mm	483 / 349 mm	11,2 kg	M22x1,5	

SCANIA

99279AP

AIR TANK

HAVA TANKI

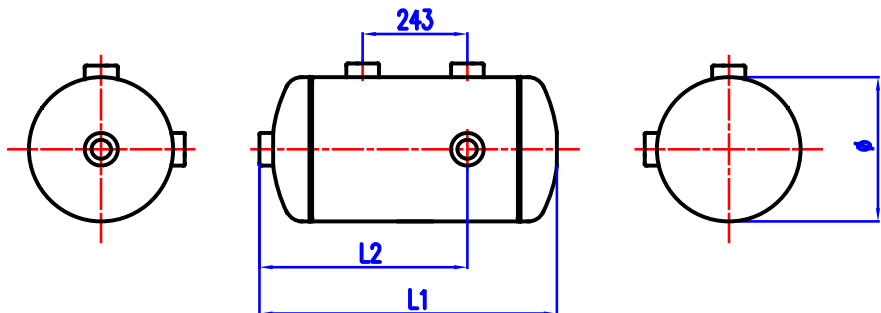

OEM / COMPARISON NO		LITER LITRE	∅	↔ L1 / L2			TYPE / TİP
1448884	14,5 bar	36	310 mm	563 / 407 mm	12,7 kg	M22x1,5	

SCANIA

99299AP

AIR TANK

HAVA TANKI

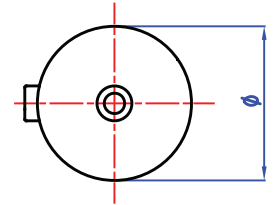
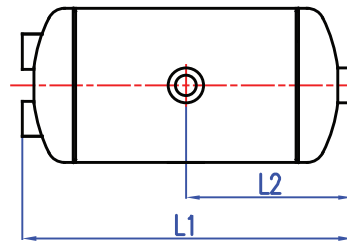
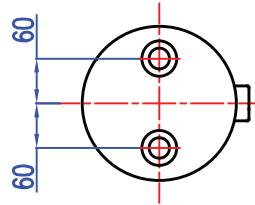

OEM / COMPARISON NO		LITER LITRE	Ø	↔ L1 / L2			TYPE / TİP
1935520	10 bar	100	396 mm	915 / 462 mm	29,9 kg	M22x1,5	

SCANIA

99341AP

AIR TANK

HAVA TANKI

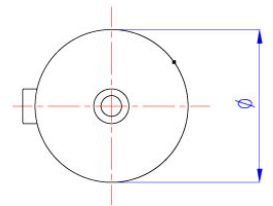
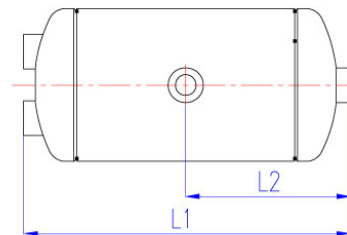
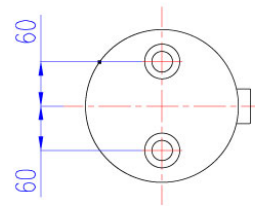

OEM / COMPARISON NO		LITER LITRE	Ø	↔ L1 / L2			TYPE / TİP
9507300070	14,5 bar	15	206 mm	513 / 342 mm	7,6 kg	M22x1,5	





SCHMITZ

99284AP

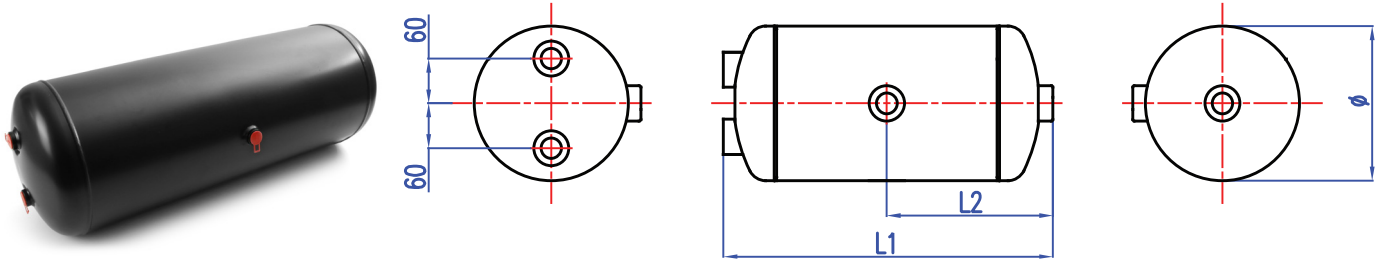
AIR TANK

HAVA TANKI



OEM / COMPARISON NO		LITER LITRE	Ø	↔ L1 / L2			TYPE / TIP
050459	12,5 bar	60	310 mm	895 / 452 mm	19,9 kg	M22x1,5	





SCHMITZ

99286AP

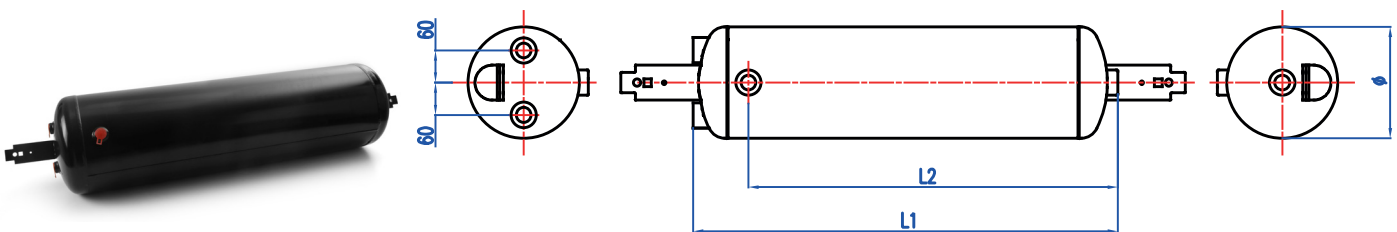
AIR TANK

HAVA TANKI



OEM / COMPARISON NO		LITER LITRE	Ø	↔ L1 / L2			TYPE / TIP
1189864	12,5 bar	80	310 mm	1157 / 1014 mm	25	M22x1,5	



SCHMITZ

99296AP

AIR TANK

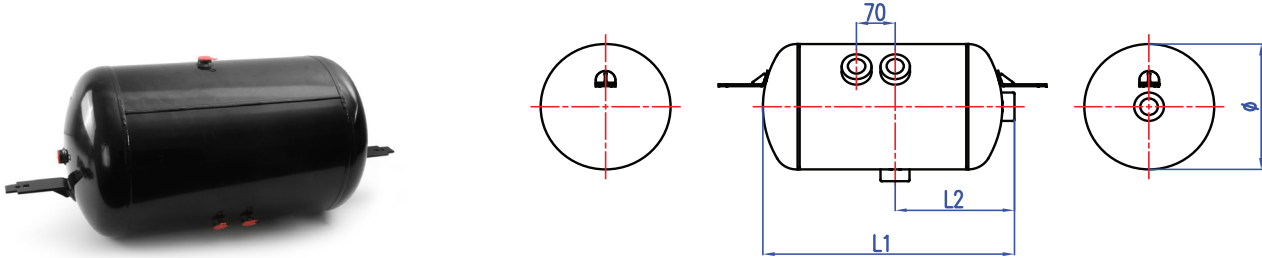
HAVA TANKI

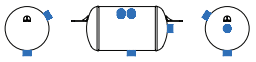

OEM / COMPARISON NO		LITER LITRE	∅	↔ L1 / L2			TYPE / TİP
1009330 115826 1189863 1193012 1219118	10 bar	80	396 mm	743 / 340 mm	26 kg	M22x1,5	



SCHMITZ

99298AP

AIR TANK

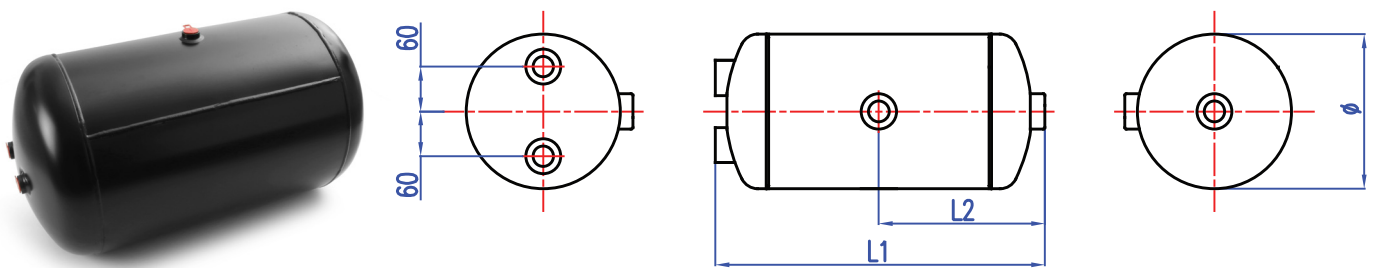
HAVA TANKI

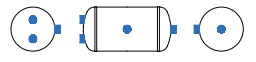

OEM / COMPARISON NO		LITER LITRE	∅	↔ L1 / L2			TYPE / TİP
050461	12,5 bar	80	396 mm	750 / 380 mm	25 kg	M22x1,5	



VOLVO

99137AP

AIR TANK

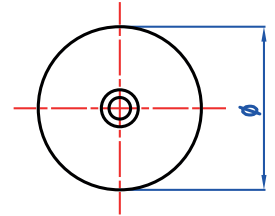
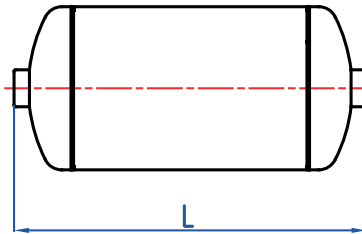
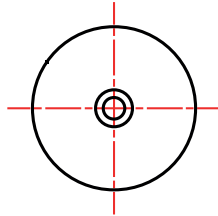
HAVA TANKI

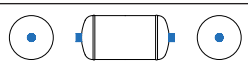

OEM / COMPARISON NO		LITER LITRE	∅	↔ L			TYPE / TİP
20579593	15,5 bar	6	206 mm	242 mm	3,9 kg	M22x1,5	



VOLVO

99154AP

AIR TANK

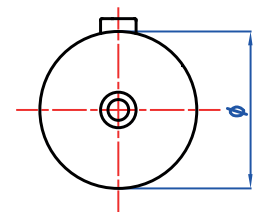
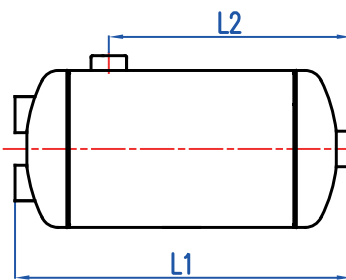
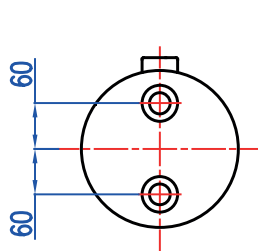
HAVA TANKI

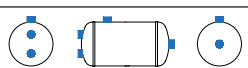

OEM / COMPARISON NO		LITER LITRE	∅	↔ L1 / L2			TYPE / TİP
20579600	15 bar	15	206 mm	515 / 359 mm	7,7 kg	M22x1,5	





VOLVO

99160AP

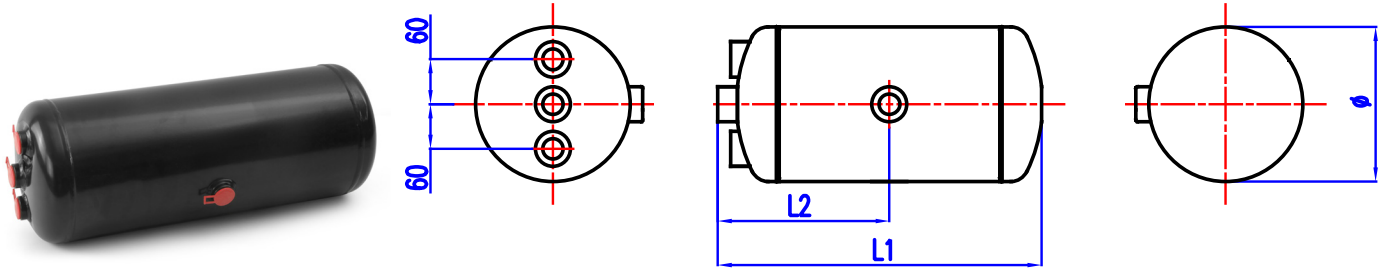
AIR TANK

HAVA TANKI



OEM / COMPARISON NO		LITER LITRE	∅	↔ L1 / L2			TYPE / TİP
20904405	15 bar	15	206 mm	550 / 282 mm	8,2 kg	M22x1,5	





VOLVO

99168AP

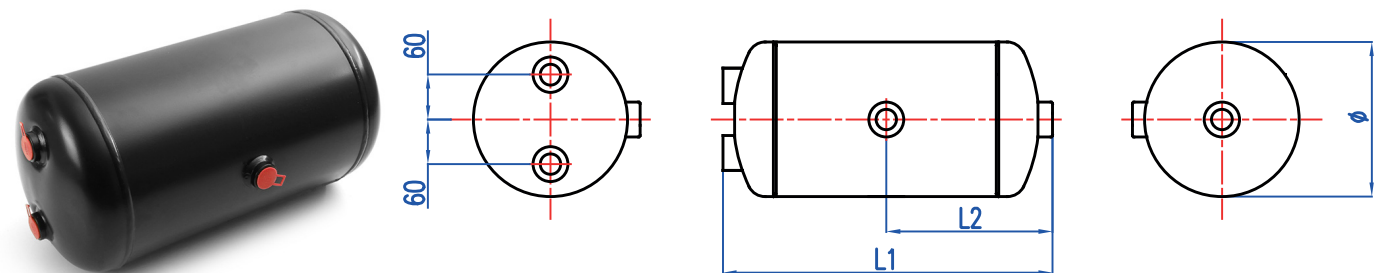
AIR TANK

HAVA TANKI



OEM / COMPARISON NO		LITER LITRE	∅	↔ L1 / L2			TYPE / TİP
20850902 3117304	15,5 bar	30	206 mm	992 / 501 mm	13,8 kg	M22x1,5	



VOLVO

99175AP

AIR TANK

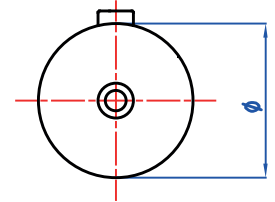
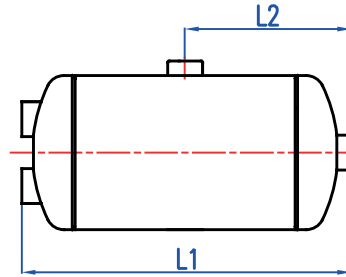
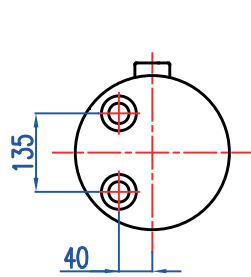
HAVA TANKI

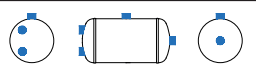

OEM / COMPARISON NO		LITER LİTRE	Ø	↔ L1 / L2			TYPE / TİP
21048245 21048254	15 bar	15	246 mm	370 / 190 mm	7 kg	M22x1,5	



VOLVO

99177AP

AIR TANK

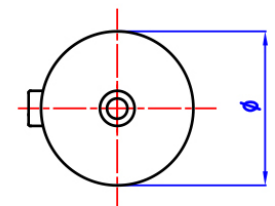
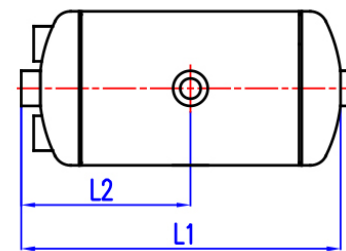
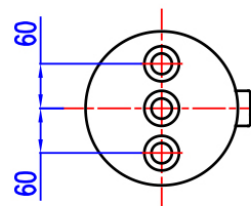
HAVA TANKI

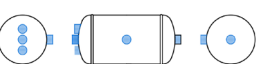

OEM / COMPARISON NO		LITER LİTRE	Ø	↔ L1 / L2			TYPE / TİP
21187782	15 bar	15	246 mm	385 / 301 mm	10,3 kg	M22x1,5	





VOLVO

99178AP

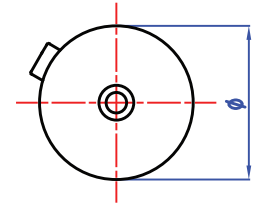
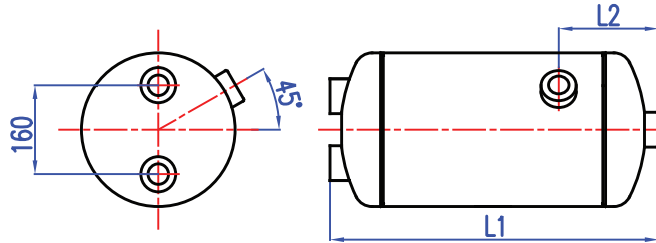
AIR TANK

HAVA TANKI



OEM / COMPARISON NO		LITER LİTRE	Ø	↔ L1 / L2			TYPE / TİP
20772295	15 bar	15	246 mm	399 / 117 mm	7,4 kg	M22x1,5	





VOLVO

99191AP

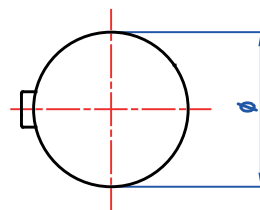
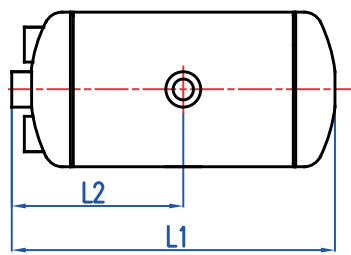
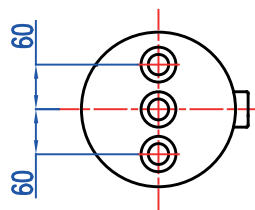
AIR TANK

HAVA TANKI



OEM / COMPARISON NO		LITER LİTRE	Ø	↔ L1 / L2			TYPE / TİP
20904407	15 bar	25	246 mm	588 / 301 mm	10,3 kg	M22x1,5	





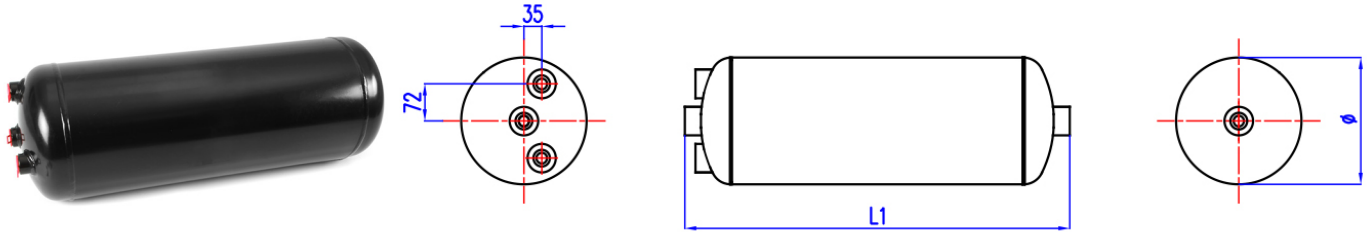

VOLVO

99206AP

AIR TANK

HAVA TANKI



OEM / COMPARISON NO		LITER LİTRE	Ø	↔ L1 / L2			TYPE / TİP
20714522	13 bar	30	246 mm	720 / 117 mm	7,4 kg	M22x1,5	  





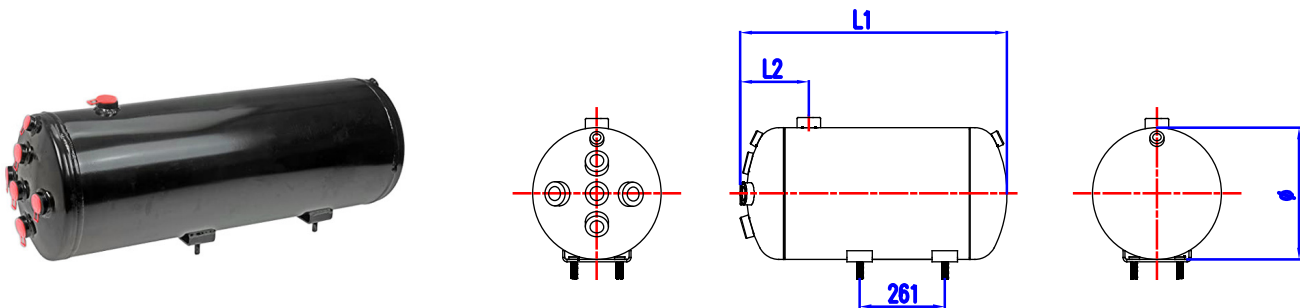

VOLVO

99222AP

AIR TANK

HAVA TANKI

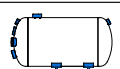

OEM / COMPARISON NO		LITER LİTRE	Ø	↔ L1 / L2			TYPE / TİP
20946636	10 bar	35	255 mm	759 / 175 mm	14 kg	M22x1,5 M16x1,5 1/4" NPT	  



VOLVO

99223AP

AIR TANK

HAVA TANKI



OEM / COMPARISON NO		LITER LITRE	Ø	↔ L1 / L2			TYPE / TİP
20946637	10 bar	35	255 mm	759 / 175 mm	14 kg	M22x1,5 M16x1,5 1/4" NPT	





VOLVO

99231AP

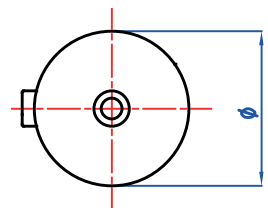
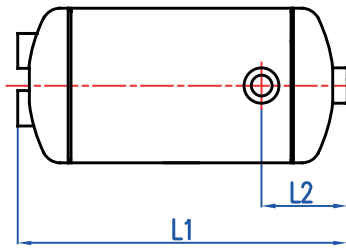
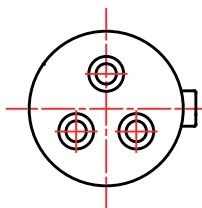
AIR TANK

HAVA TANKI



OEM / COMPARISON NO		LITER LITRE	Ø	↔ L1 / L2			TYPE / TİP
20579604 20948176	15 bar	25	276 mm	490 / 121 mm	10 kg	M22x1,5	

VOLVO

99234AP

AIR TANK

HAVA TANKI

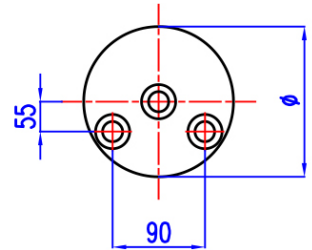
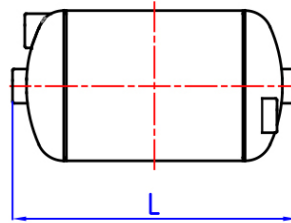
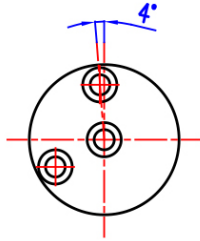

OEM / COMPARISON NO		LITER LİTRE	Ø	↔ L1 / L2			TYPE / TİP
20714520	13 bar	25	276 mm	500 mm	10 kg	M22x1,5	

VOLVO

99235AP

AIR TANK

HAVA TANKI

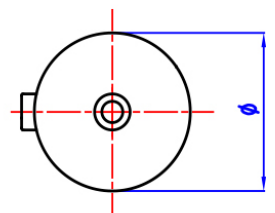
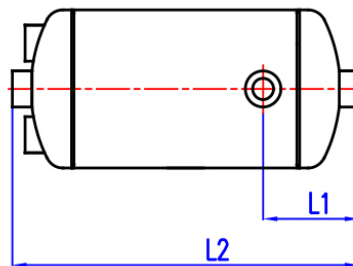
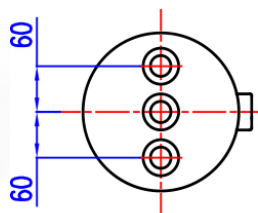

OEM / COMPARISON NO		LITER LİTRE	Ø	↔ L1 / L2			TYPE / TİP
21187789	15 bar	25	276 mm	740 / 208 mm	14,4 kg	M22x1,5	





VOLVO

99237AP

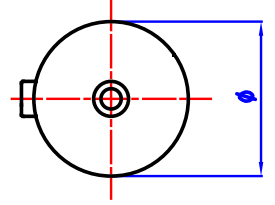
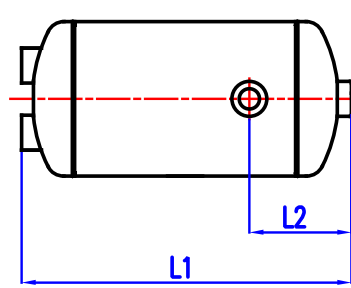
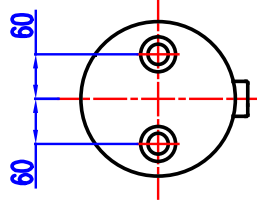
AIR TANK

HAVA TANKI



OEM / COMPARISON NO		LITER LITRE	∅	↔ L1 / L2			TYPE / TİP
20485246 20579606	15 bar	30	276 mm	575 / 121 mm	11,4 kg	M22x1,5	



VOLVO

99244AP

AIR TANK

HAVA TANKI



OEM / COMPARISON NO		LITER LITRE	∅	↔ L1 / L2			TYPE / TİP
21187793	15 bar	38	276 mm	710 / 208 mm	14,4 kg	M22x1,5	





VOLVO

99250AP

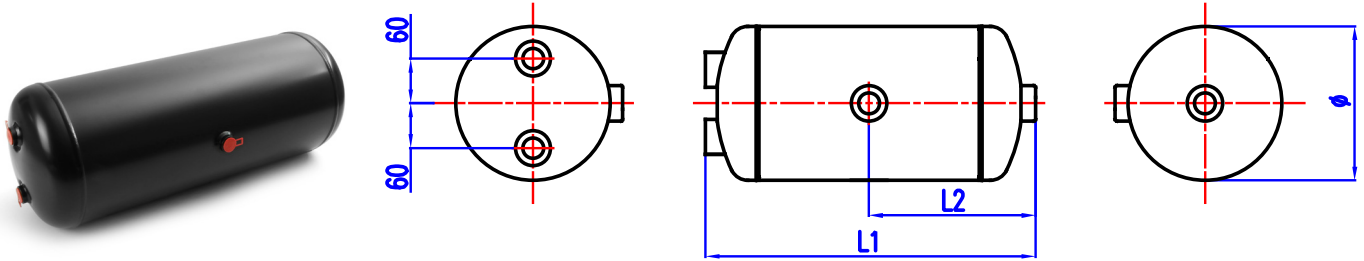
AIR TANK

HAVA TANKI



OEM / COMPARISON NO		LITER LITRE	Ø	↔ L1 / L2			TYPE / TİP
11117328	15,5 bar	40	276 mm	760 / 385 mm	14,5 kg	M22x1,5	





VOLVO

99255AP

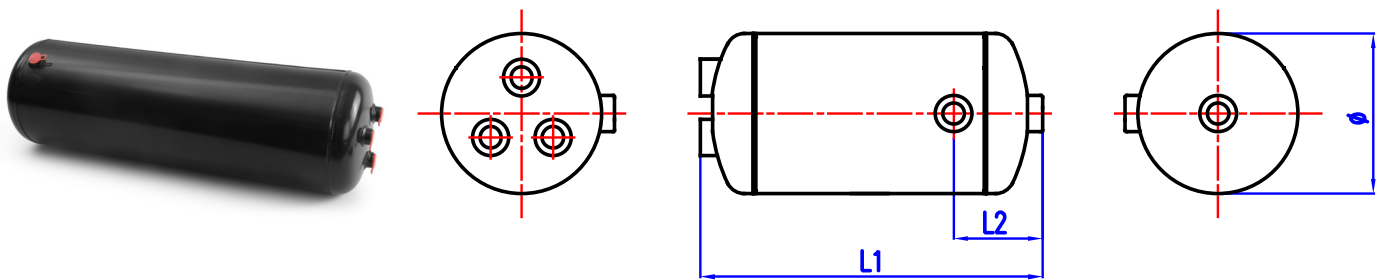
AIR TANK

HAVA TANKI



OEM / COMPARISON NO		LITER LITRE	Ø	↔ L1 / L2			TYPE / TİP
020984637	15 bar	50	276 mm	931 / 110 mm	14,3 kg	M22x1,5	





VOLVO

99291AP

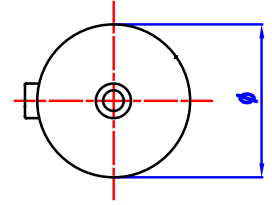
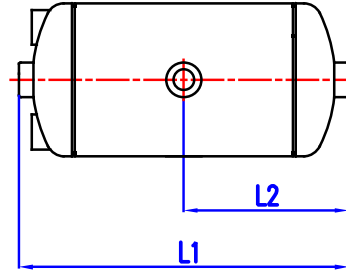
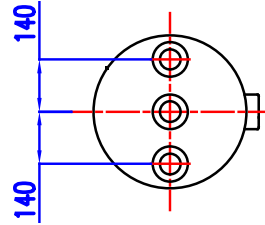
AIR TANK

HAVA TANKI



OEM / COMPARISON NO		LITER LITRE	Ø	↔ L1 / L2			TYPE / TİP
21187795	15 bar	39	396 mm	417 / 208 mm	15,1 kg	M22x1,5	





VOLVO

99292AP

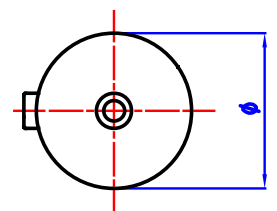
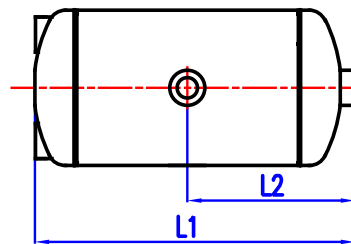
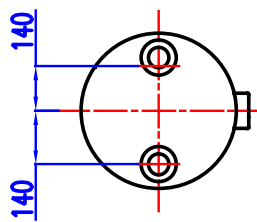
AIR TANK

HAVA TANKI



OEM / COMPARISON NO		LITER LITRE	Ø	↔ L1 / L2			TYPE / TİP
1628927 20392308 20485247 20579608	15 bar	50	396 mm	495 / 254 mm	17,5	M22x1,5	





WABCO

99114AP

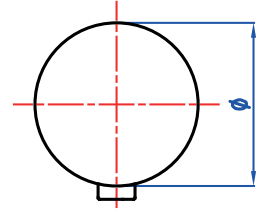
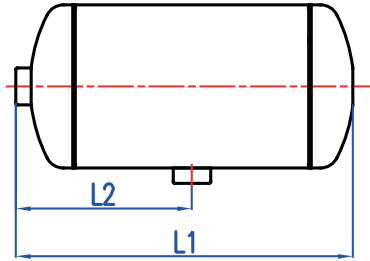
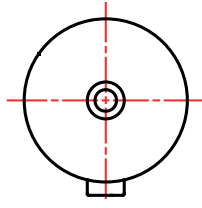
AIR TANK

HAVA TANKI



OEM / COMPARISON NO		LITER LITRE	Ø	↔ L1 / L2			TYPE / TİP
9510050100	15,5 bar	1	102 mm	170 / 115 mm	1,3 kg	M22x1,5	





WABCO

99121AP

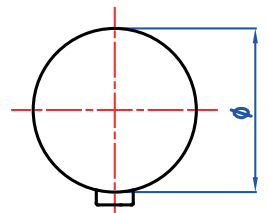
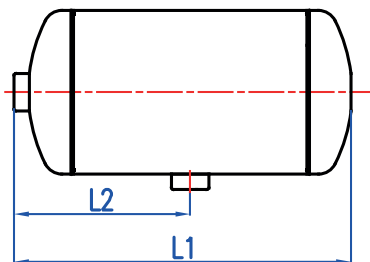
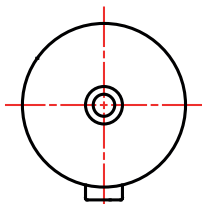
AIR TANK

HAVA TANKI



OEM / COMPARISON NO		LITER LITRE	Ø	↔ L1 / L2			TYPE / TİP
9500200080	12,5 bar	4	154 mm	273 / 143 mm	2,5 kg	M22x1,5	





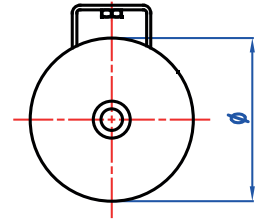
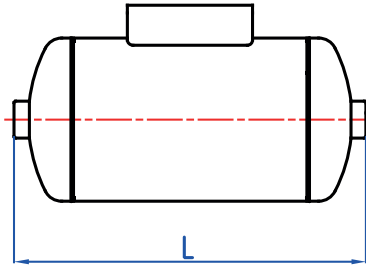
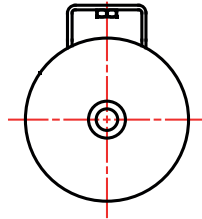

WABCO

99123AP

AIR TANK

HAVA TANKI

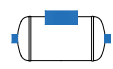

OEM / COMPARISON NO		LITER LİTRE	Ø	 L			TYPE / TİP
4510054800 9502050010	15,5 bar	5	154 mm	332 mm	4,3 kg	M22x1,5	  





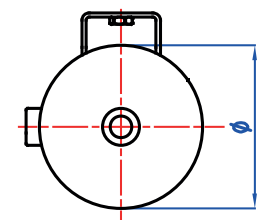
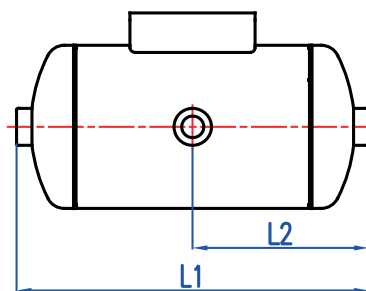
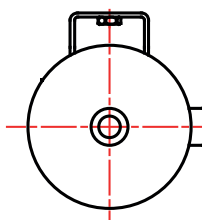

WABCO

99124AP

AIR TANK

HAVA TANKI

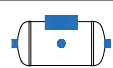

OEM / COMPARISON NO		LITER LİTRE	Ø	 L1 / L2			TYPE / TİP
9501050010	20 bar	5	154 mm	341 / 171 mm	6,5 kg	M22x1,5	  



WABCO

99129AP

AIR TANK

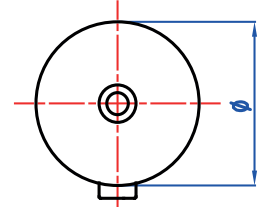
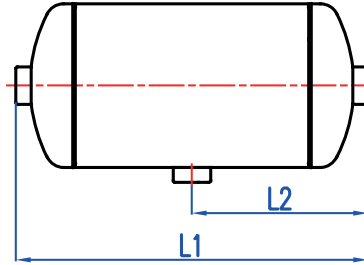
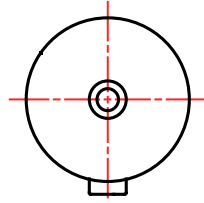
HAVA TANKI

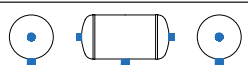

OEM / COMPARISON NO		LITER LİTRE	∅	↔ L1 / L2			TYPE / TİP
9501100020	20 bar	10	154 mm	615 / 308 mm	6,5 kg	M22x1,5	



WABCO

99135AP

AIR TANK

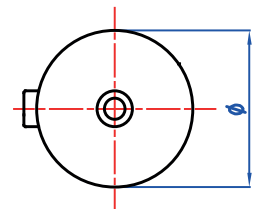
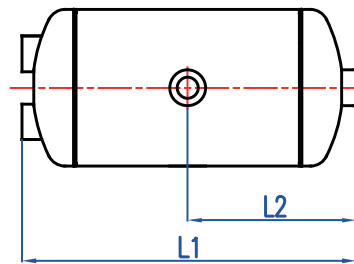
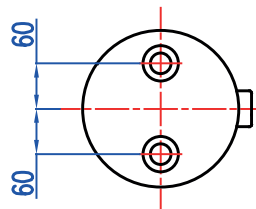
HAVA TANKI

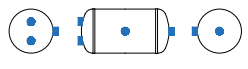

OEM / COMPARISON NO		LITER LİTRE	∅	↔ L1 / L2			TYPE / TİP
9501100020	15,5 bar	6	206 mm	241 / 125 mm	4,2 kg	M22x1,5	





WABCO

99143AP

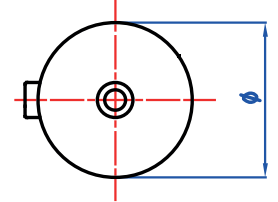
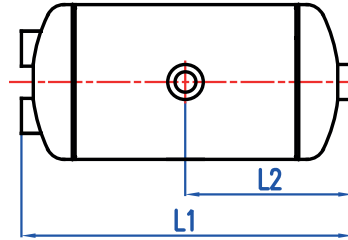
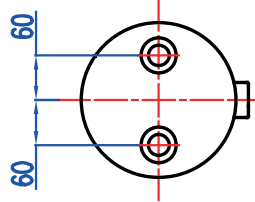
AIR TANK

HAVA TANKI



OEM / COMPARISON NO		LITER LITRE	Ø	↔ L1 / L2			TYPE / TIP
9504109020	15,5 bar	10	206 mm	355 / 182 mm	5,7 kg	M22x1,5	





WABCO

99151AP

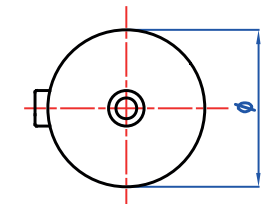
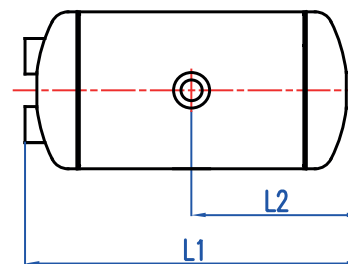
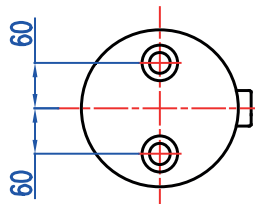
AIR TANK

HAVA TANKI



OEM / COMPARISON NO		LITER LITRE	Ø	↔ L1 / L2			TYPE / TIP
9504100040	15,5 bar	10	206 mm	370 / 190 mm	5,9 kg	M22x1,5	





WABCO

99167AP

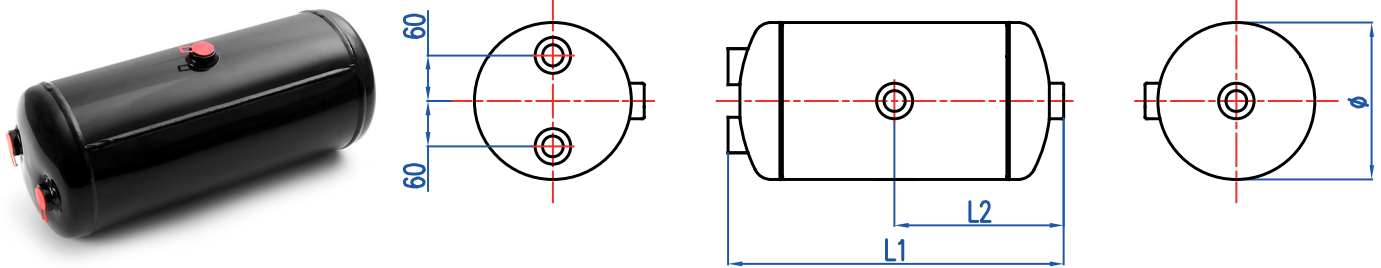
AIR TANK

HAVA TANKI



OEM / COMPARISON NO		LITER LITRE	∅	↔ L1 / L2			TYPE / TİP
9504200030 9504200100	15,5 bar	20	206 mm	692 / 351 mm	9,9 kg	M22x1,5	





WABCO

99168AP

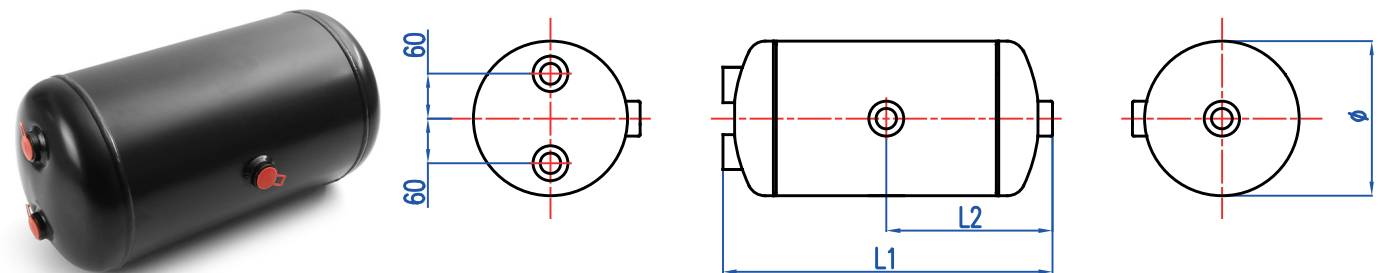
AIR TANK

HAVA TANKI



OEM / COMPARISON NO		LITER LITRE	∅	↔ L1 / L2			TYPE / TİP
9504300010	15,5 bar	30	206 mm	992 / 501 mm	13,8 kg	M22x1,5	





WABCO

99179AP

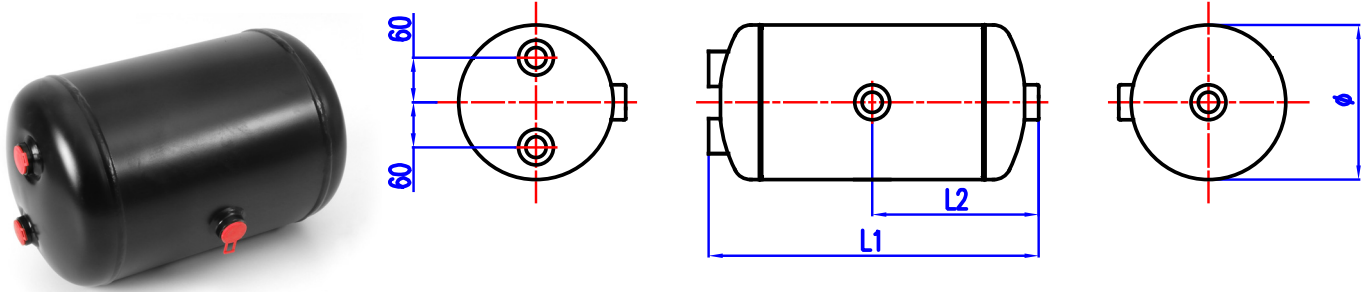
AIR TANK

HAVA TANKI



OEM / COMPARISON NO		LITER LITRE	Ø	↔ L1 / L2			TYPE / TİP
9505160030	14 bar	16	246 mm	410 / 210 mm	7,2 kg	M22x1,5	





WABCO

99180AP

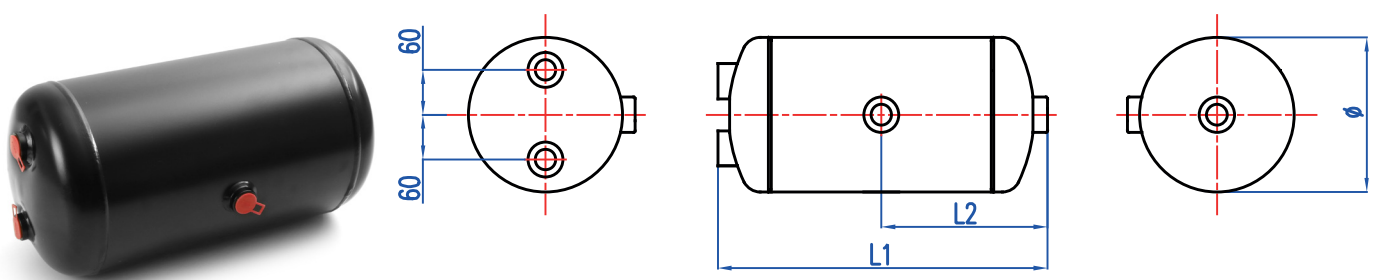
AIR TANK

HAVA TANKI



OEM / COMPARISON NO		LITER LITRE	Ø	↔ L1 / L2			TYPE / TİP
9505200030	15,5 bar	20	246 mm	495 / 252 mm	8,9 kg	M22x1,5	





WABCO

99185AP

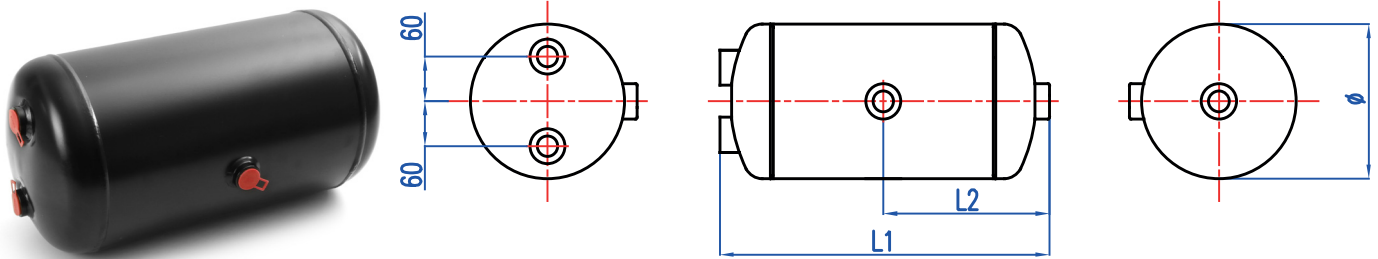
AIR TANK

HAVA TANKI



OEM / COMPARISON NO		LITER LİTRE	Ø	↔ L1 / L2			TYPE / TİP
9505200020	15,5 bar	20	246 mm	506 / 258 mm	9,1 kg	M22x1,5	





WABCO

99200AP

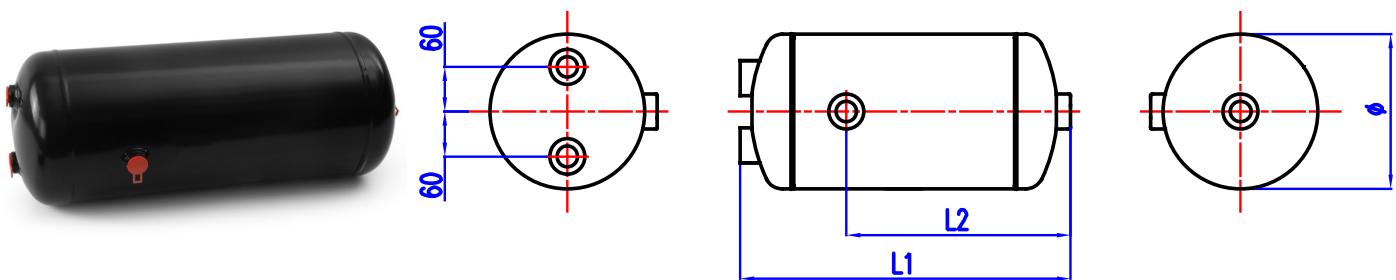
AIR TANK

HAVA TANKI



OEM / COMPARISON NO		LITER LİTRE	Ø	↔ L1 / L2			TYPE / TİP
9505270040	15,5 bar	27	246 mm	645 / 464 mm	11,1 kg	M22x1,5	





WABCO

99201AP

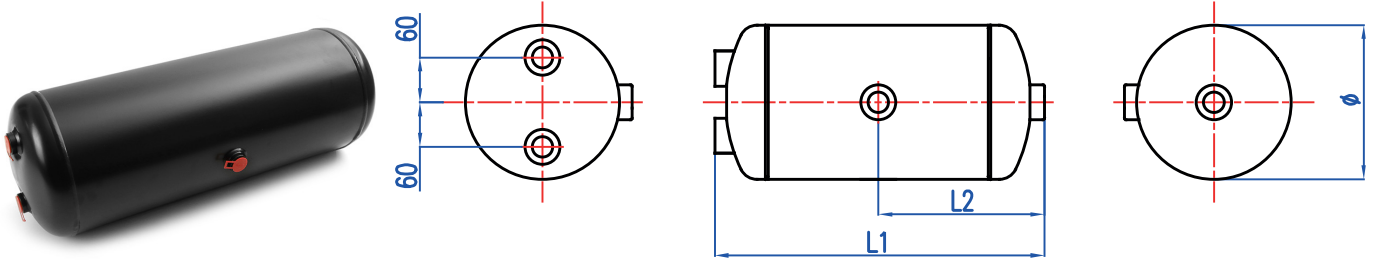
AIR TANK

HAVA TANKI



OEM / COMPARISON NO		LITER LITRE	∅	↔ L1 / L2			TYPE / TİP
9505300020	15,5 bar	30	246 mm	709 / 359 mm	12 kg	M22x1,5	





WABCO

99210AP

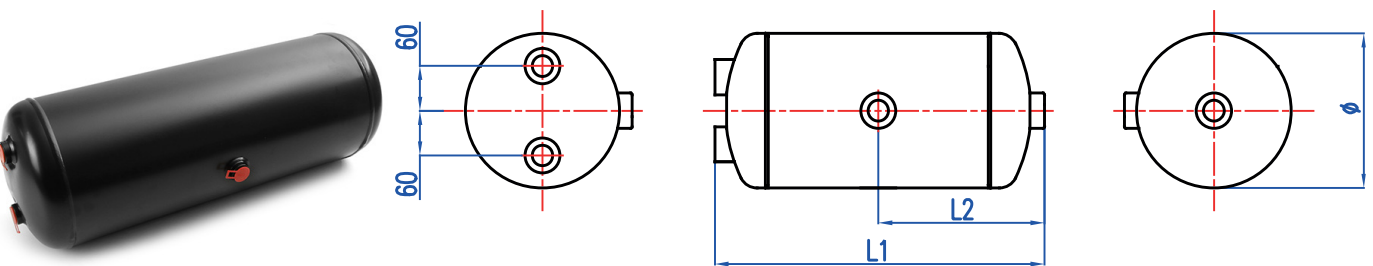
AIR TANK

HAVA TANKI



OEM / COMPARISON NO		LITER LITRE	∅	↔ L1 / L2			TYPE / TİP
4510373010 9505370010	15,5 bar	37	246 mm	862 / 436 mm	14,3 kg	M22x1,5	





WABCO

99211AP

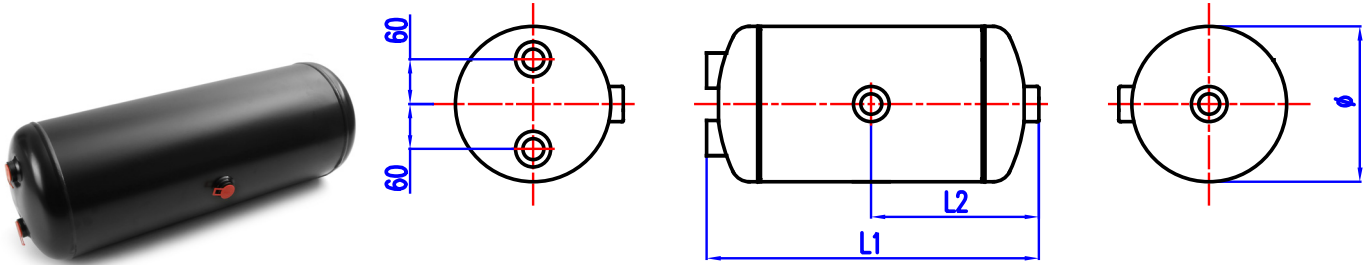
AIR TANK

HAVA TANKI



OEM / COMPARISON NO		LITER LITRE	Ø	↔ L1 / L2			TYPE / TIP
4510403010	8,5 bar	40	246 mm	915 / 462 mm	15,2 kg	M22x1,5	





WABCO

99215AP

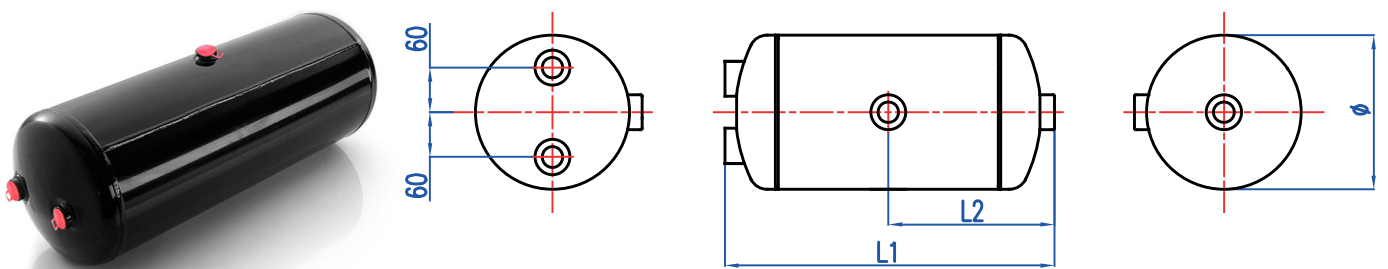
AIR TANK

HAVA TANKI



OEM / COMPARISON NO		LITER LITRE	Ø	↔ L1 / L2			TYPE / TIP
9505600020	15,5 bar	60	246 mm	1365 / 687 mm	21,9 kg	M22x1,5	



WABCO

99227AP

AIR TANK

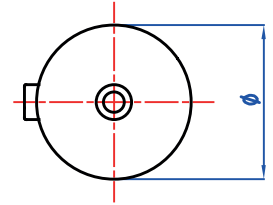
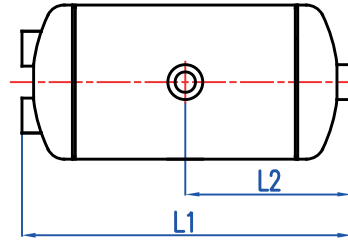
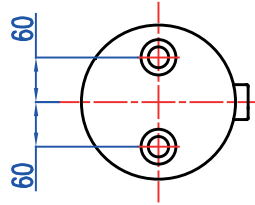
HAVA TANKI

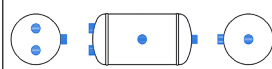

OEM / COMPARISON NO		LITER LITRE	Ø	↔ L1 / L2			TYPE / TİP
9507200050	15,5 bar	20	276 mm	412 / 211 mm	8,6 kg	M22x1,5	





WABCO

99236AP

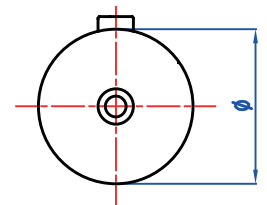
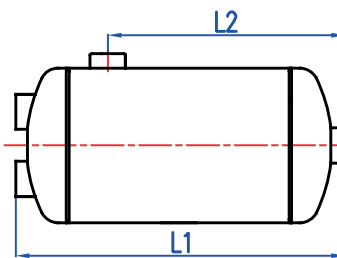
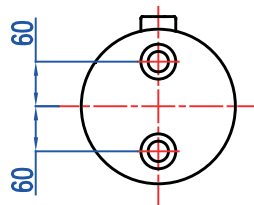
AIR TANK

HAVA TANKI



OEM / COMPARISON NO		LITER LITRE	Ø	↔ L1 / L2			TYPE / TİP
9507300050	14,5 bar	30	276 mm	568 / 388 mm	11,3 kg	M22x1,5	





WABCO

99249AP

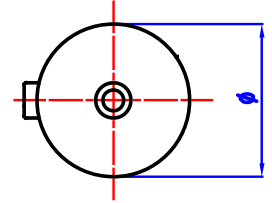
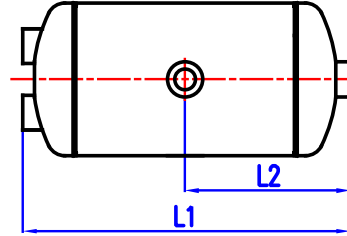
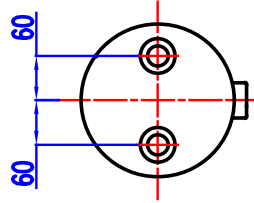
AIR TANK

HAVA TANKI



OEM / COMPARISON NO		LITER LITRE	Ø	↔ L1 / L2			TYPE / TİP
4510403110	12,5 bar	40	276 mm	745 / 377 mm	13,8 kg	M22x1,5	





WABCO

99250AP

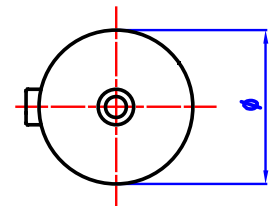
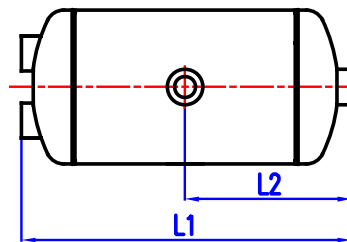
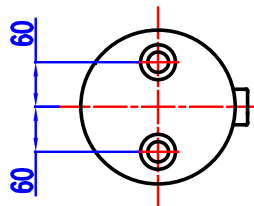
AIR TANK

HAVA TANKI



OEM / COMPARISON NO		LITER LITRE	Ø	↔ L1 / L2			TYPE / TİP
9507400020	15,5 bar	40	276 mm	760 / 385 mm	14,5 kg	M22x1,5	





WABCO

99258AP

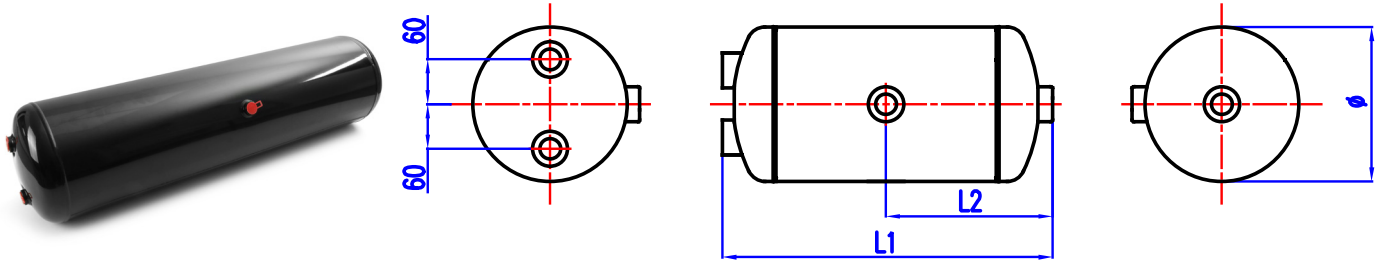
AIR TANK

HAVA TANKI



OEM / COMPARISON NO		LITER LITRE	Ø	↔ L1 / L2			TYPE / TİP
9507600020	15,5 bar	60	276 mm	1108 / 559 mm	20,5 kg	M22x1,5	



WABCO

99259AP

AIR TANK

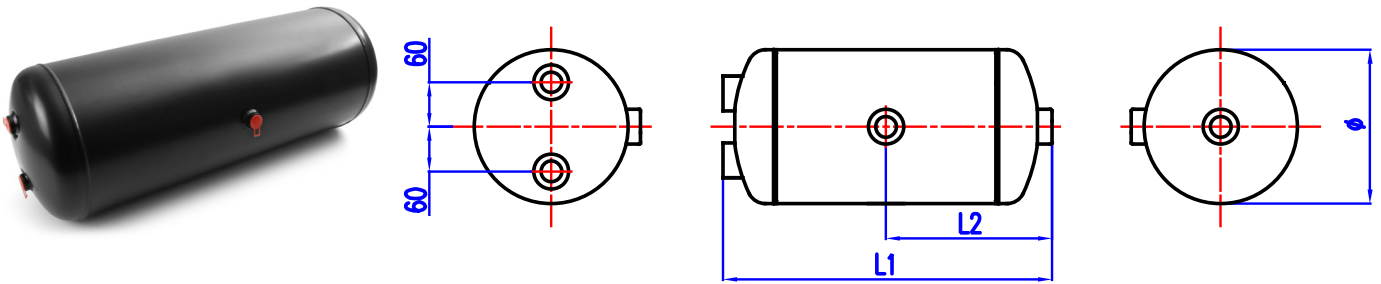
HAVA TANKI

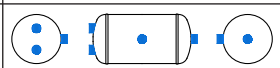

OEM / COMPARISON NO		LITER LITRE	Ø	↔ L1 / L2			TYPE / TİP
4510853010	12,5 bar	85	276 mm	1502 / 756 mm	27 kg	M22x1,5	



WABCO

99270AP

AIR TANK

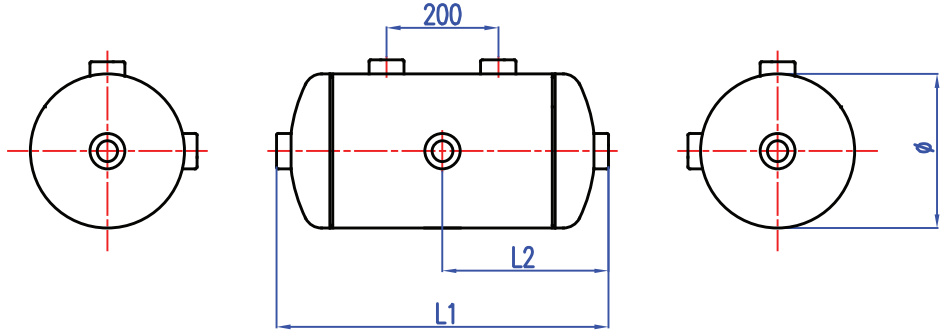
HAVA TANKI

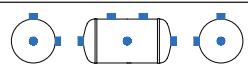

OEM / COMPARISON NO		LITER LİTRE	Ø	↔ L1 / L2			TYPE / TİP
9508450010	12,5 bar	45	300 mm	740 / 370 mm	15,3 kg	M22x1,5	



WABCO

99271AP

AIR TANK

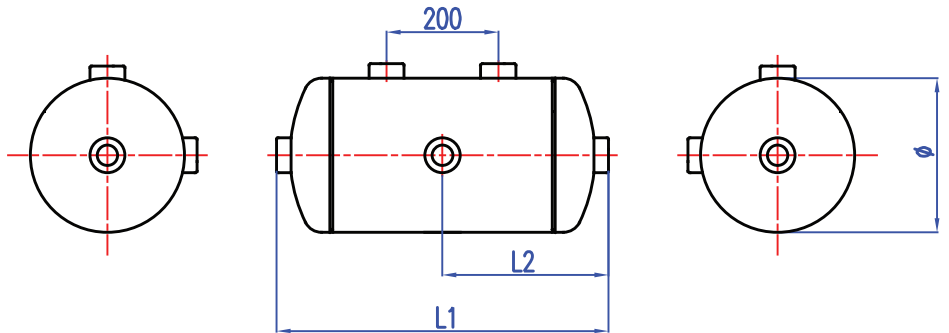
HAVA TANKI

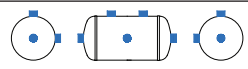

OEM / COMPARISON NO		LITER LİTRE	Ø	↔ L1 / L2			TYPE / TİP
9500600090	12,5 bar	60	300 mm	950 / 475 mm	19,2 kg	M22x1,5	





WABCO

99284AP

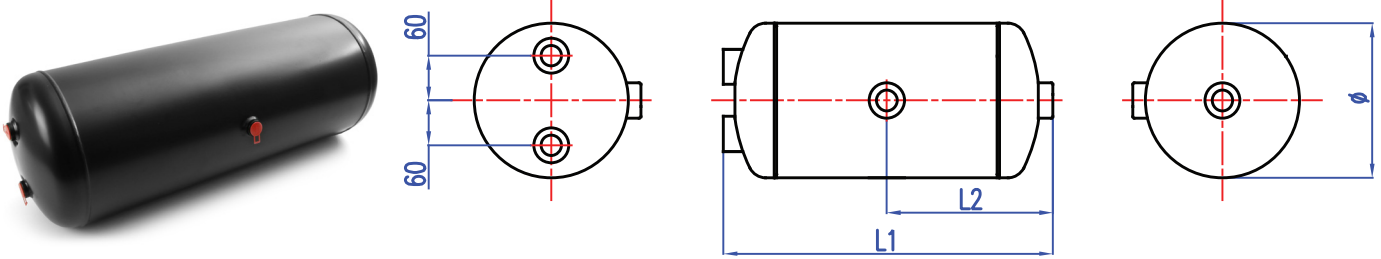
AIR TANK

HAVA TANKI



OEM / COMPARISON NO		LITER LITRE	Ø	↔ L1 / L2			TYPE / TİP
9500600030	12,5 bar	60	310 mm	895 / 452 mm	19,9 kg	M22x1,5	





WABCO

99293AP

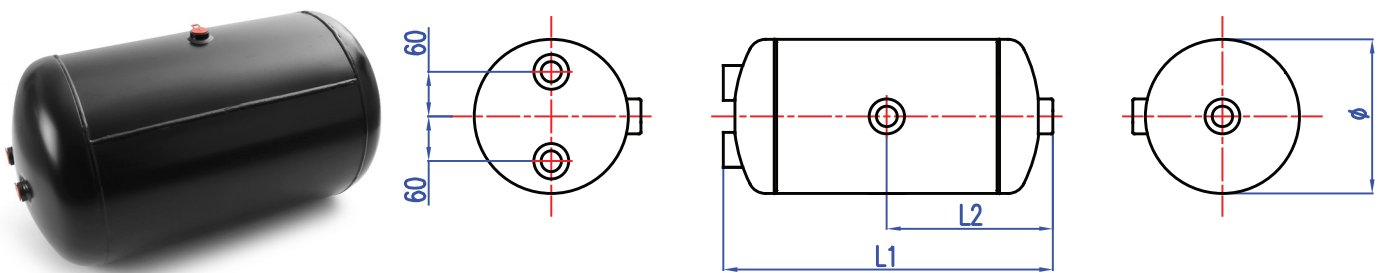
AIR TANK

HAVA TANKI



OEM / COMPARISON NO		LITER LITRE	Ø	↔ L1 / L2			TYPE / TİP
9500600040	12,5 bar	60	396 mm	580 / 295 mm	20,1 kg	M22x1,5	





WABCO

99298AP

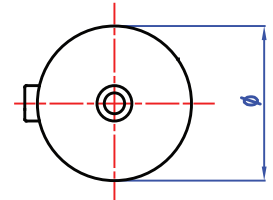
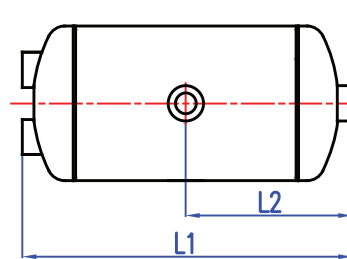
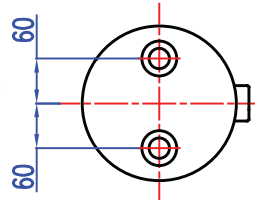
AIR TANK

HAVA TANKI



OEM / COMPARISON NO		LITER LİTRE	Ø	↔ L1 / L2			TYPE / TİP
9500800020	12,5 bar	80	396 mm	750 / 380 mm	25 kg	M22x1,5	





WABCO

99299AP

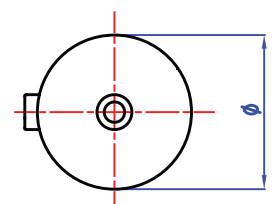
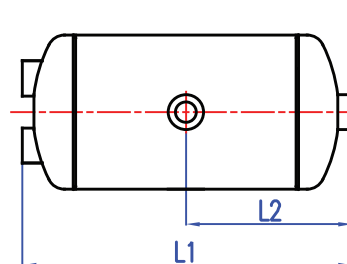
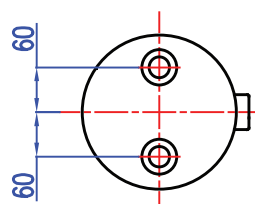
AIR TANK

HAVA TANKI



OEM / COMPARISON NO		LITER LİTRE	Ø	↔ L1 / L2			TYPE / TİP
9501000020	10 bar	100	396 mm	915 / 462 mm	29,9 kg	M22x1,5	





WABCO

99347AP

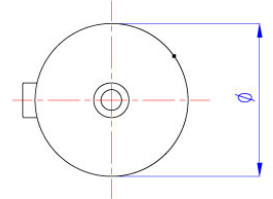
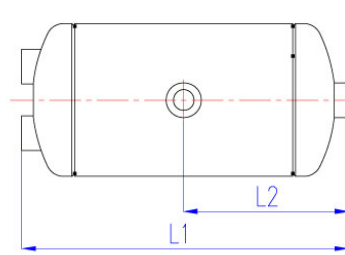
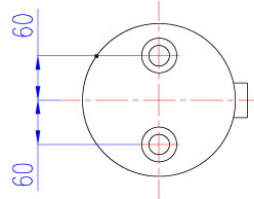
AIR TANK

HAVA TANKI



OEM / COMPARISON NO	 15,5 bar	LITER LITRE 30	Ø 276 mm	↔ L1 / L2 583 / 296 mm	 11,5 kg	 M22x1,5	TYPE / TİP 
9507300070	15,5 bar	30	276 mm	583 / 296 mm	11,5 kg	M22x1,5	



AMERICAN APPLICATIONS

99319AP

AIR TANK

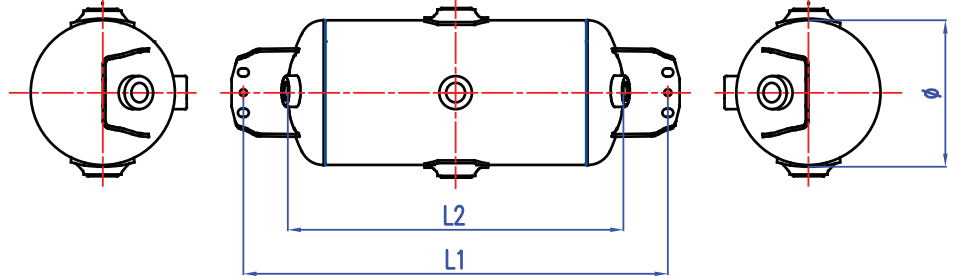
HAVA TANKI

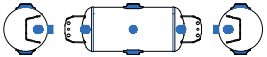

OEM / COMPARISON NO		LITER LITRE	Ø	↔ L1 / L2			TYPE / TIP
X1212	10 bar	25	246 mm	699 / 572 mm	11,5 kg	3/8" - 3/4" - 1/4" NPT	



AMERICAN APPLICATIONS

99320AP

AIR TANK

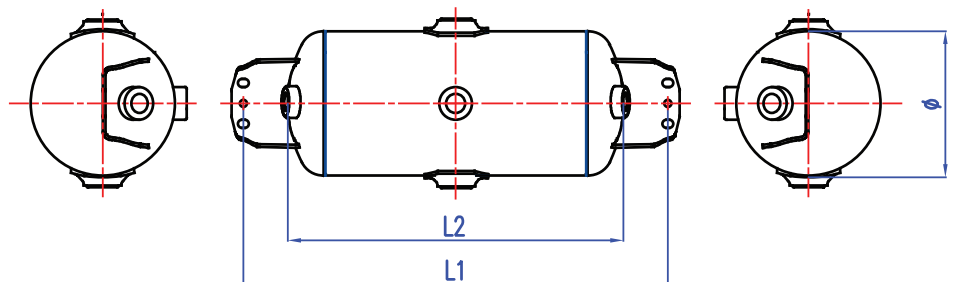
HAVA TANKI

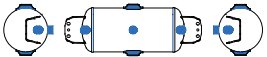

OEM / COMPARISON NO		LITER LITRE	Ø	↔ L1 / L2			TYPE / TIP
X1213	10 bar	47	300 mm	749 / 686 mm	13,5 kg	3/8" - 3/4" - 1/4" NPT	





AMERICAN APPLICATIONS

99346AP

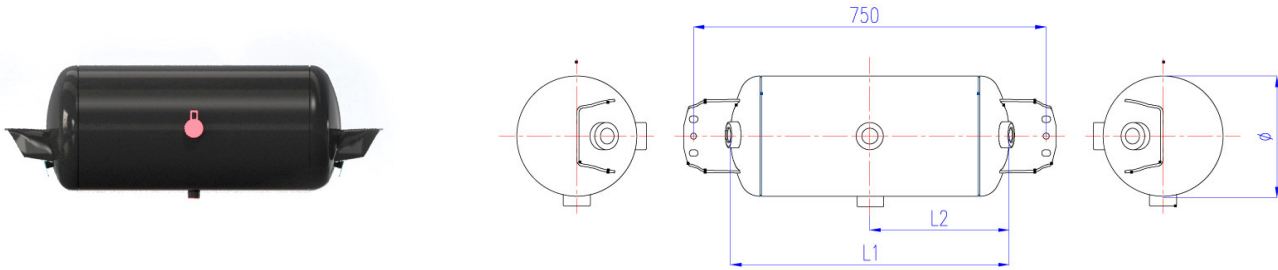
AIR TANK

HAVA TANKI



OEM / COMPARISON NO		LITER LİTRE	Ø	↔ L1 / L2			TYPE / TİP
X1217	10 bar	47	308 mm	750 / 687 mm	13,5 kg	3/8"-18 NPT 3/4"-14 NPT 1/4"-18 NPT	





AMERICAN APPLICATIONS

99349AP

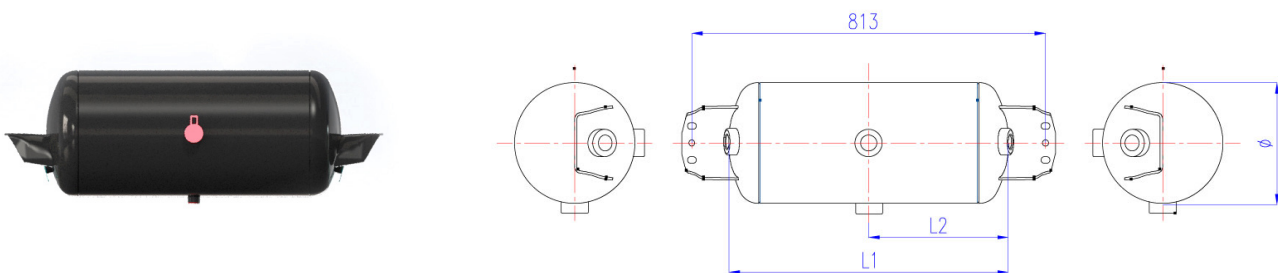
AIR TANK

HAVA TANKI



OEM / COMPARISON NO		LITER LİTRE	Ø	↔ L1 / L2			TYPE / TİP
X1215	10 bar	23	206 mm	750 / 375 mm	11,5 kg	3/8"-18 NPT 3/4"-14 NPT 1/4"-18 NPT	



AMERICAN APPLICATIONS

99350AP

AIR TANK

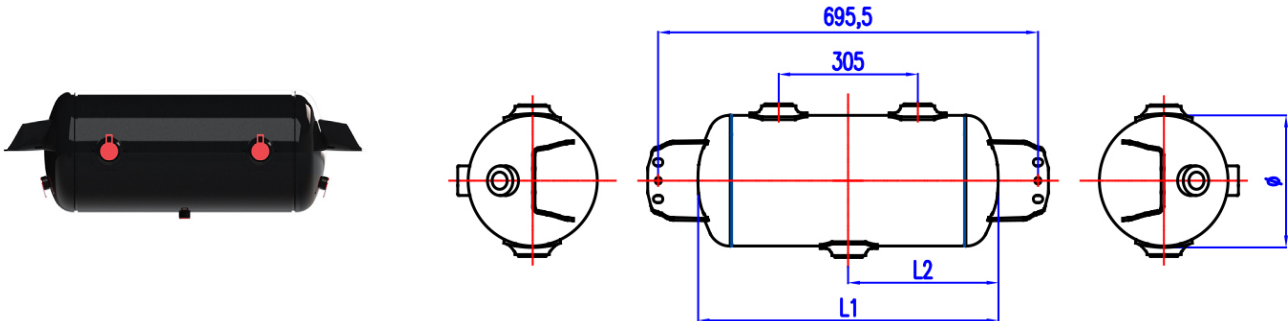
HAVA TANKI

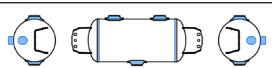

OEM / COMPARISON NO	 10 bar	LITER LITRE	Ø	↔ L1 / L2			TYPE / TİP
X1219	10 bar	24	246 mm	569 / 284 mm	11,5 kg	3/8" NPT 3/4" NPT 1/4" NPT	



AMERICAN APPLICATIONS

99358AP

AIR TANK

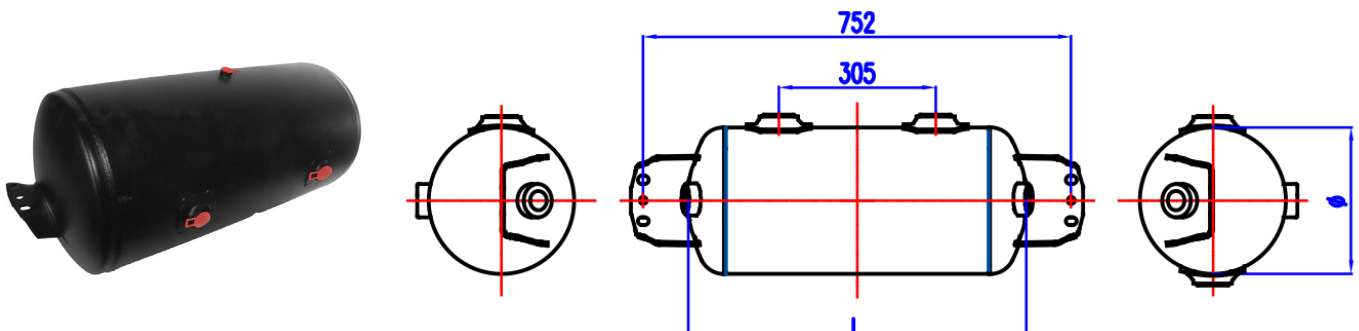
HAVA TANKI

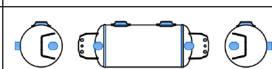

OEM / COMPARISON NO	 10 bar	LITER LITRE	Ø	↔ L1 / L2			TYPE / TİP
X1227	10 bar	47	308 mm	688 / 344 mm	15,8 kg	3/4" NPT 3/8" NPT 1/4" NPT	



AMERICAN APPLICATIONS

99359AP

AIR TANK

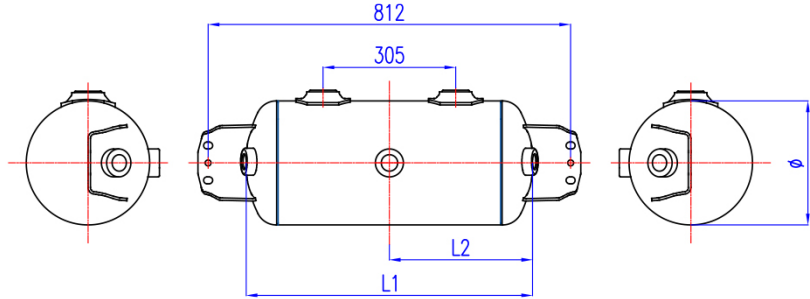
HAVA TANKI

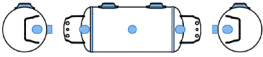

OEM / COMPARISON NO		LITER LİTRE	Ø	↔ L1 / L2			TYPE / TİP
X1228	10 bar	23	206 mm	749 / 375 mm	11,5 kg	3/8" NPT 3/4" NPT 1/4" NPT	





AMERICAN APPLICATIONS

99360AP

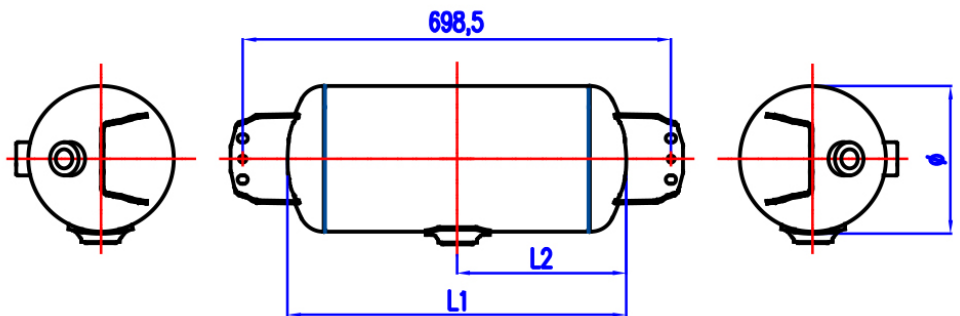
AIR TANK

HAVA TANKI



OEM / COMPARISON NO		LITER LİTRE	Ø	↔ L1 / L2			TYPE / TİP
X1227	10 bar	24	246 mm	572 / 286 mm	11,1 kg	3/4" NPT 3/8" NPT 1/4" NPT	





AMERICAN APPLICATIONS

99363AP

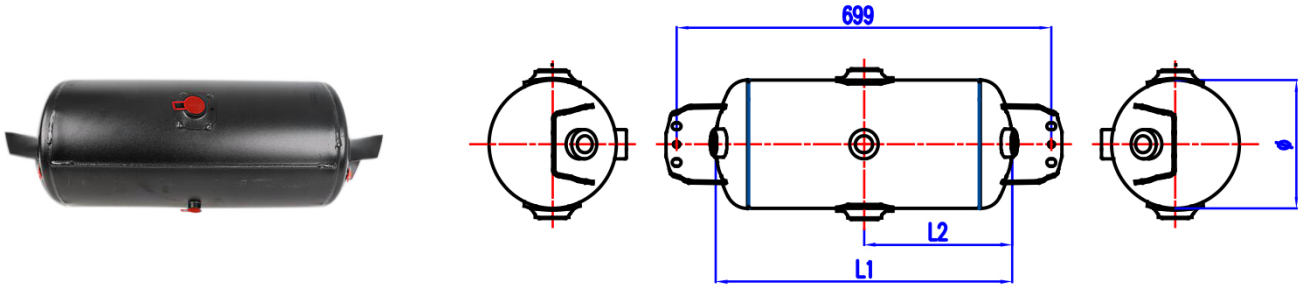
AIR TANK

HAVA TANKI



OEM / COMPARISON NO		LITER LITRE	∅	↔ L1 / L2			TYPE / TİP
X1233	10 bar	24	246 mm	572 / 286 mm	11,3 kg	3/8" NPT 3/4" NPT 1/4" NPT	



AMERICAN APPLICATIONS

99364AP

AIR TANK

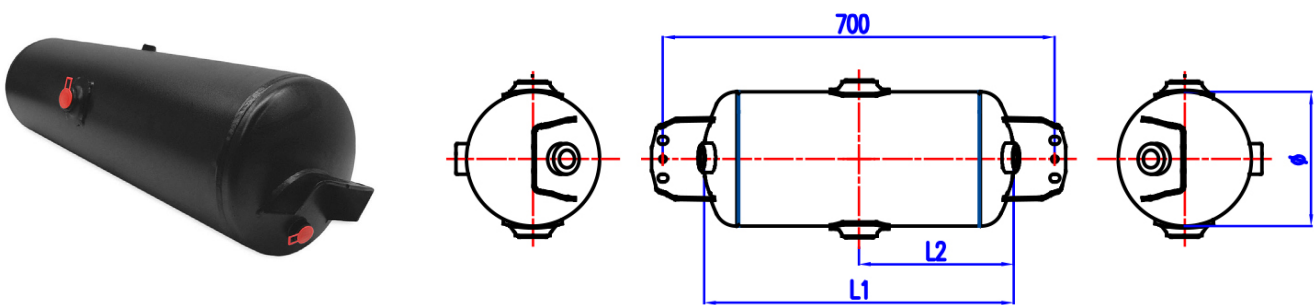
HAVA TANKI

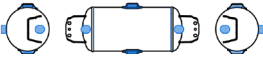

OEM / COMPARISON NO		LITER LITRE	∅	↔ L1 / L2			TYPE / TİP
X1234	10 bar	24	246 mm	573 / 287 mm	11,4 kg	1/2" NPT 1/4" NPT	



AMERICAN APPLICATIONS

99365AP

AIR TANK

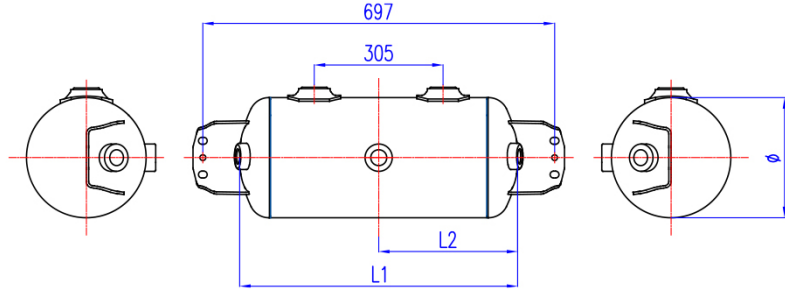
HAVA TANKI

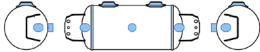

OEM / COMPARISON NO	 10 bar	LITER LİTRE	Ø	↔ L1 / L2	 12 kg	 3/8" NPT 3/4" NPT 1/4" NPT	TYPE / TİP
X1235	10 bar	24	246 mm	572 / 285 mm	12 kg	3/8" NPT 3/4" NPT 1/4" NPT	





AMERICAN APPLICATIONS

99366AP

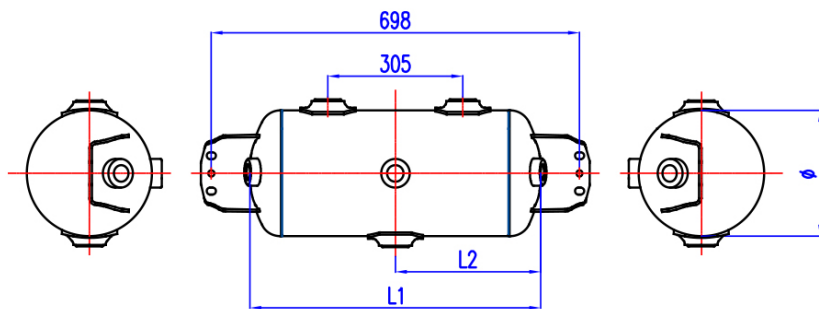
AIR TANK

HAVA TANKI



OEM / COMPARISON NO	 10 bar	LITER LİTRE	Ø	↔ L1 / L2	 11,5 kg	 3/8" NPT 3/4" NPT 1/4" NPT	TYPE / TİP
X1236	10 bar	24	246 mm	571 / 286 mm	11,5 kg	3/8" NPT 3/4" NPT 1/4" NPT	





AMERICAN APPLICATIONS

99367AP

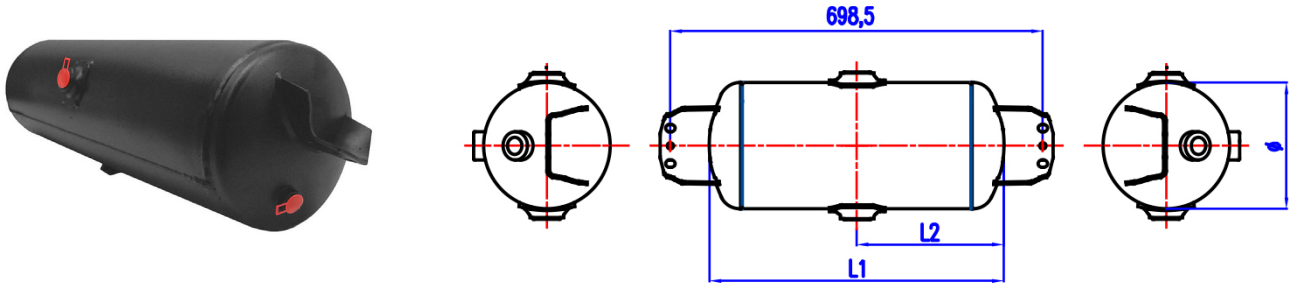
AIR TANK

HAVA TANKI



OEM / COMPARISON NO		LITER LITRE	Ø	↔ L1 / L2			TYPE / TIP
X1235	10 bar	24	246 mm	572 / 286 mm	11,3 kg	1/2" NPT 3/8" NPT 1/4" NPT	





AMERICAN APPLICATIONS

99368AP

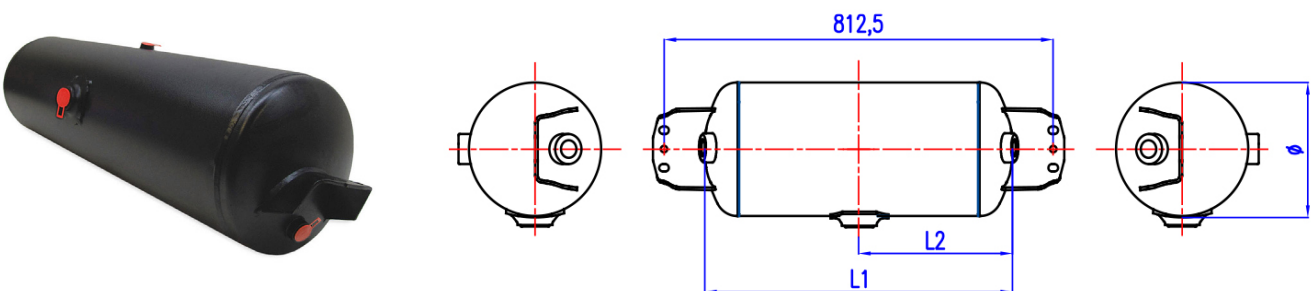
AIR TANK

HAVA TANKI







OEM / COMPARISON NO		LITER LITRE	Ø	↔ L1 / L2			TYPE / TIP
X1236	10 bar	23	206 mm	750 / 375 mm	11,8 kg	3/8" NPT 3/4" NPT 1/4" NPT	

99196AP

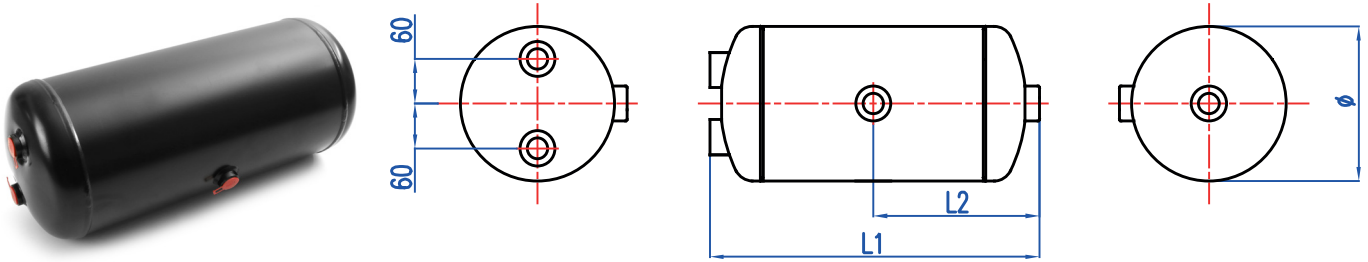
AIR TANK

HAVA TANKI



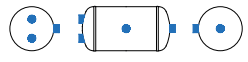



OEM / COMPARISON NO		LITER LİTRE	Ø	↔ L1 / L2			TYPE / TİP
275001000025366	15,5 bar	25	246 mm	610 / 310 mm	10,6 kg	M22x1,5	

99302AP

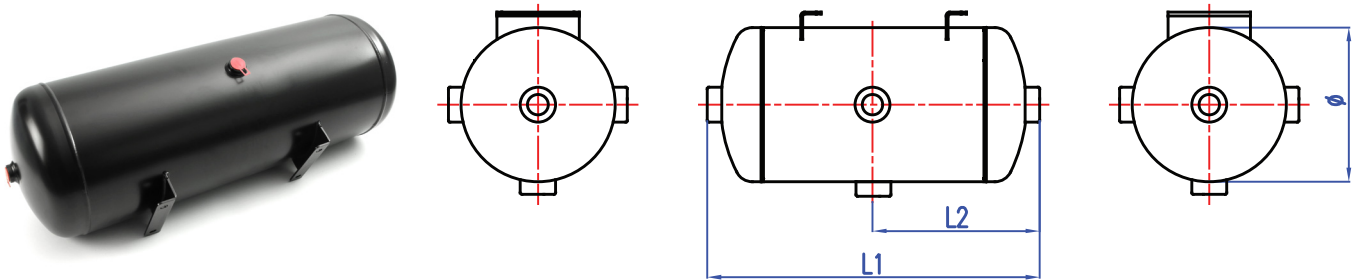
AIR TANK

HAVA TANKI



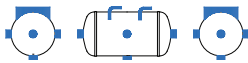



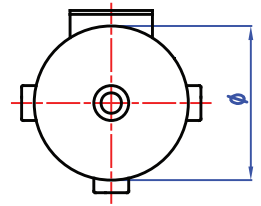
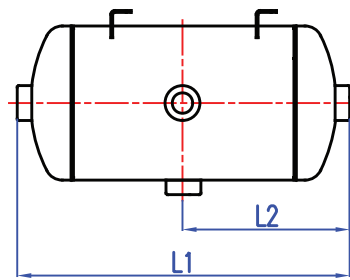
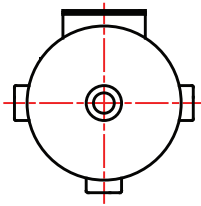

OEM / COMPARISON NO		LITER LİTRE	Ø	↔ L1 / L2			TYPE / TİP
SPA190	12,5 bar	60	300 mm	910 / 455 mm	19,2 kg	M22x1,5	

99303AP

AIR TANK

HAVA TANKI







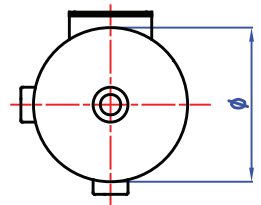
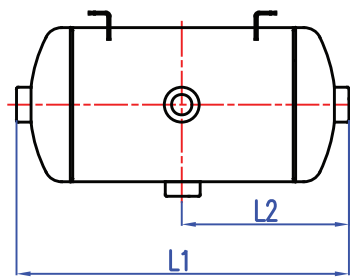
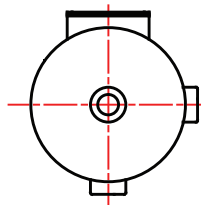

OEM / COMPARISON NO		LITER LİTRE	Ø	↔ L1 / L2			TYPE / TİP
SPA188 SPA185M	12,5 bar	60	300 mm	912 / 456 mm	19,9 kg	M22x1,5	  

99304AP

AIR TANK

HAVA TANKI







OEM / COMPARISON NO		LITER LİTRE	Ø	↔ L1 / L2			TYPE / TİP
SPA189	12,5 bar	60	300 mm	910 / 455 mm	19,7 kg	M22x1,5	  

99305AP

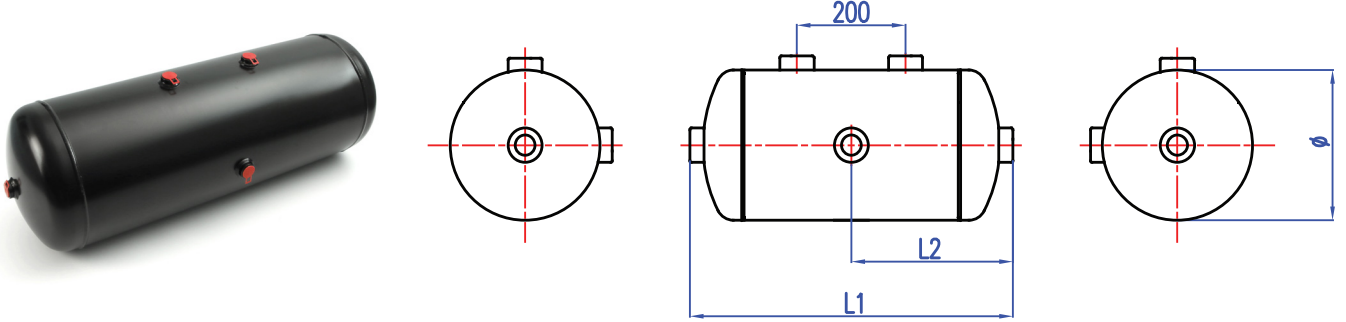
AIR TANK

HAVA TANKI



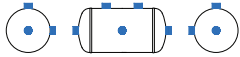



OEM / COMPARISON NO		LITER LİTRE	Ø	↔ L1 / L2			TYPE / TİP
SPA212	12,5 bar	60	300 mm	912 / 456 mm	19 kg	M22x1,5	

99306AP

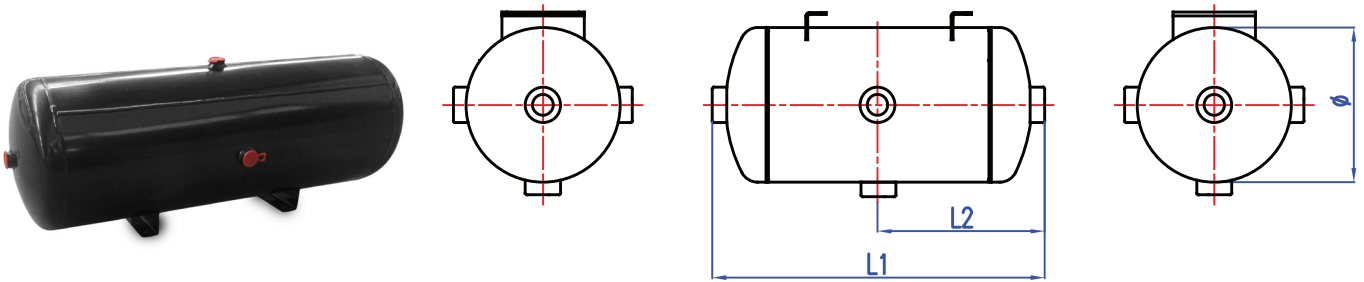
AIR TANK

HAVA TANKI







OEM / COMPARISON NO		LITER LİTRE	Ø	↔ L1 / L2			TYPE / TİP
SPA181M	12,5 bar	20	206 mm	709 / 355 mm	11 kg	M22x1,5	

99307AP

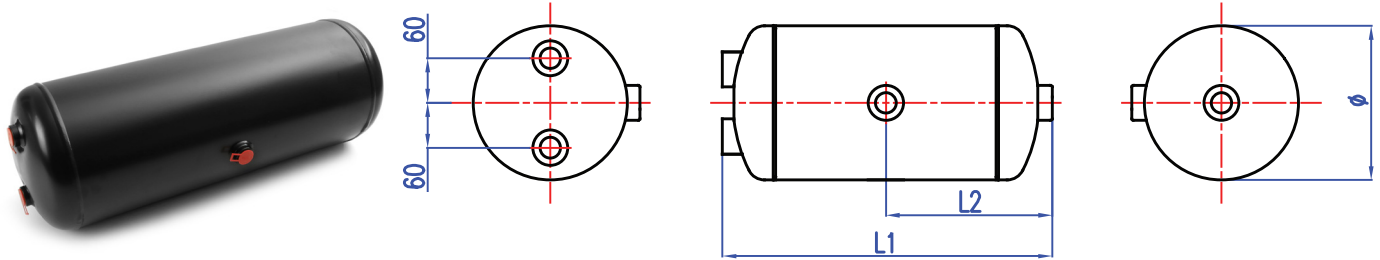
AIR TANK

HAVA TANKI







OEM / COMPARISON NO		LITER LİTRE	Ø	↔ L1 / L2			TYPE / TİP
SPA1006	12,5 bar	37	246 mm	852 / 431 mm	14,3 kg	M22x1,5	

99308AP

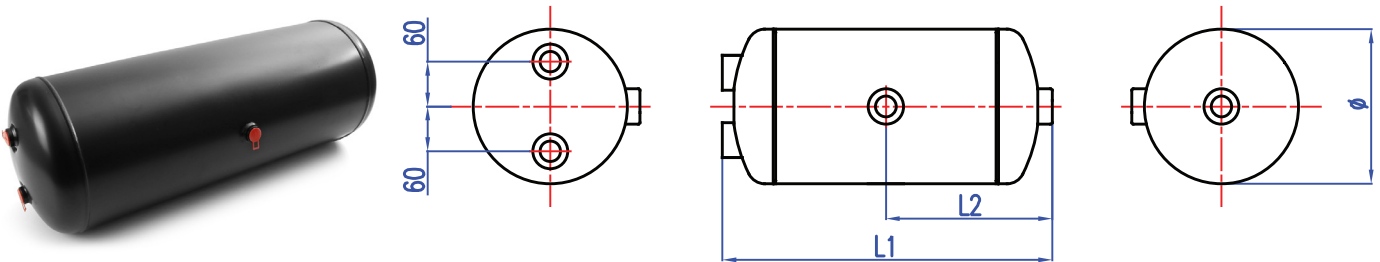
AIR TANK

HAVA TANKI







OEM / COMPARISON NO		LITER LİTRE	Ø	↔ L1 / L2			TYPE / TİP
SPA1009	12,5 bar	40	310 mm	620 / 315 mm	13,8 kg	M22x1,5	

99310AP

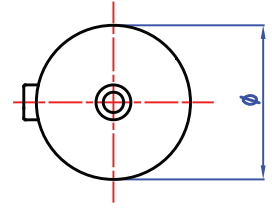
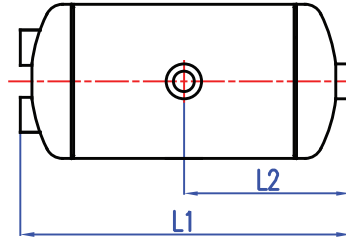
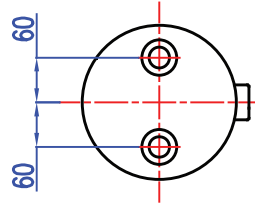
AIR TANK

HAVA TANKI



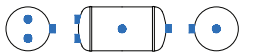



OEM / COMPARISON NO		LITER LİTRE	Ø	↔ L1 / L2			TYPE / TİP
SPA1030	12,5 bar	50	310 mm	742 / 376mm	16,1 kg	M22x1,5	

99311AP

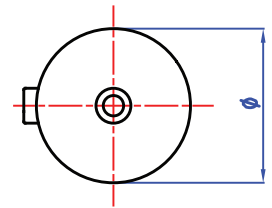
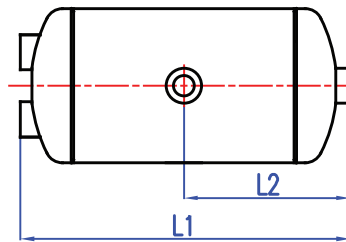
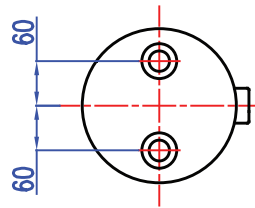
AIR TANK

HAVA TANKI



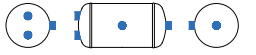



OEM / COMPARISON NO		LITER LİTRE	Ø	↔ L1 / L2			TYPE / TİP
SPA1000	12,5 bar	5	206 mm	215 / 112 mm	3,9 kg	M22x1,5	

99312AP

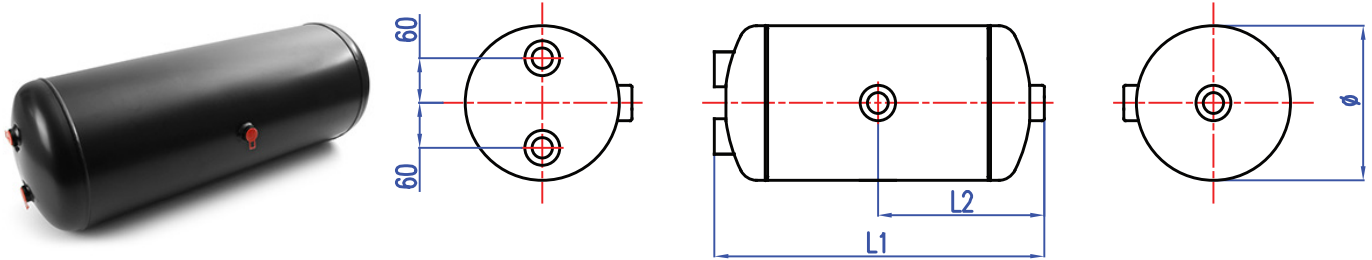
AIR TANK

HAVA TANKI



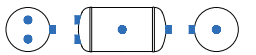



OEM / COMPARISON NO		LITER LİTRE	∅	↔ L1 / L2			TYPE / TİP
SPA1010	12,5 bar	60	246 mm	1352 / 681 mm	23 kg	M22x1,5	

99313AP

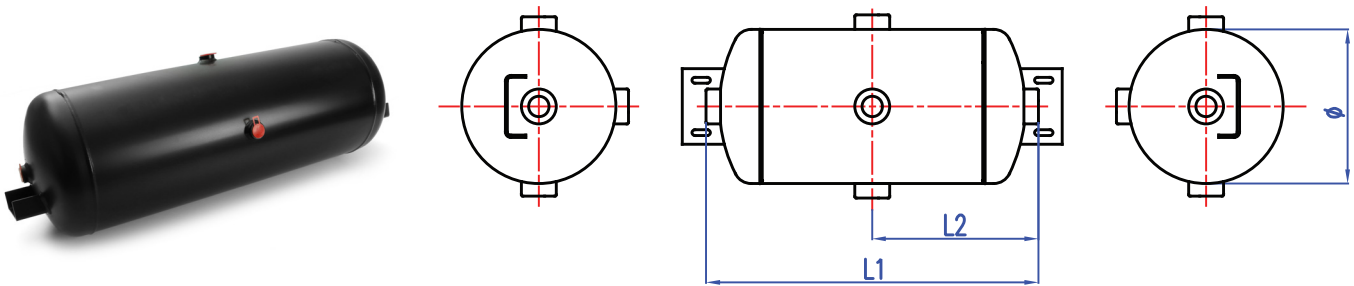
AIR TANK

HAVA TANKI







OEM / COMPARISON NO		LITER LİTRE	∅	↔ L1 / L2			TYPE / TİP
SPA184M	12,5 bar	60	300 mm	912 / 456 mm	20 kg	M22x1,5	

99314AP

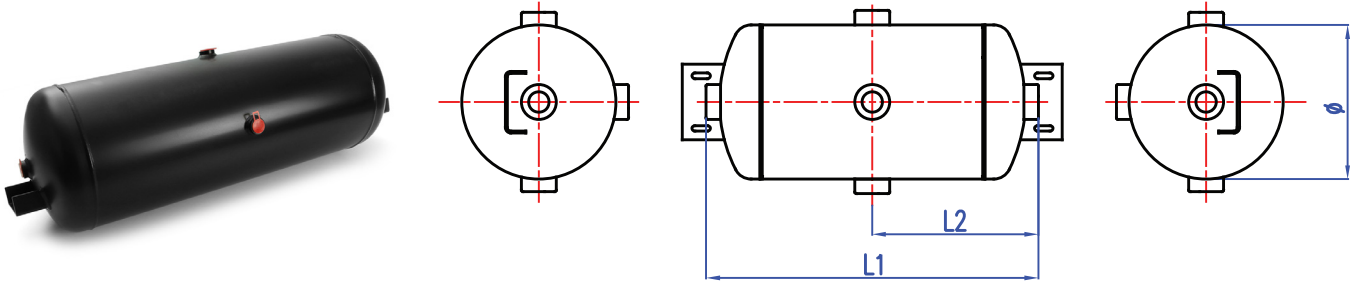
AIR TANK

HAVA TANKI







OEM / COMPARISON NO		LITER LİTRE	Ø	↔ L1 / L2			TYPE / TİP
SPA182M	12,5 bar	50	300 mm	757 / 379 mm	16,5 kg	M22x1,5	

99315AP

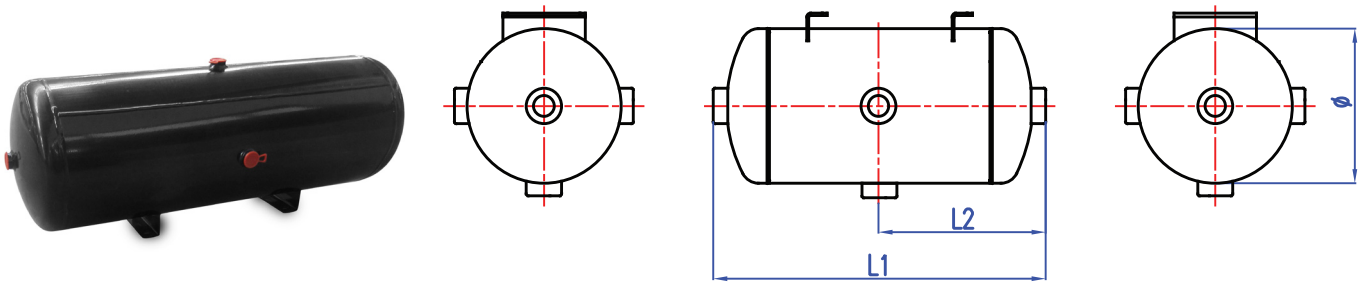
AIR TANK

HAVA TANKI







OEM / COMPARISON NO		LITER LİTRE	Ø	↔ L1 / L2			TYPE / TİP
SPA183M	12,5 bar	50	300 mm	757 / 379 mm	16,5 kg	M22x1,5	

99316AP

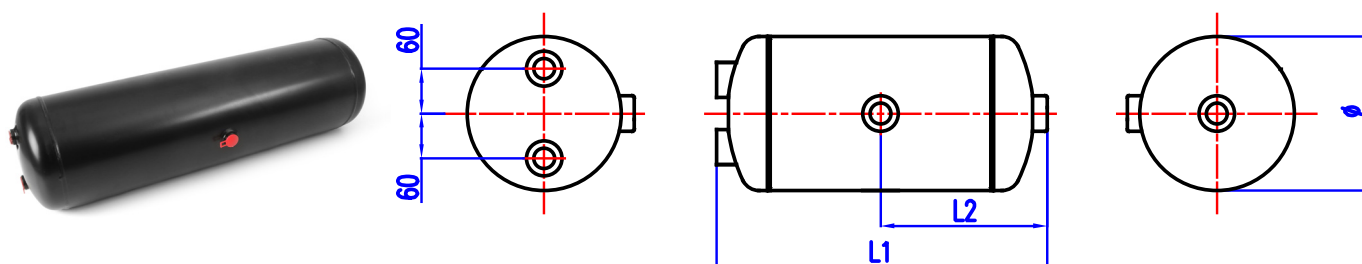
AIR TANK

HAVA TANKI







OEM / COMPARISON NO		LITER LİTRE	∅	↔ L1 / L2			TYPE / TİP
X1035	15,5 bar	43,5	255 mm	927 / 468 mm	16,1 kg	M22x1,5	

99317AP

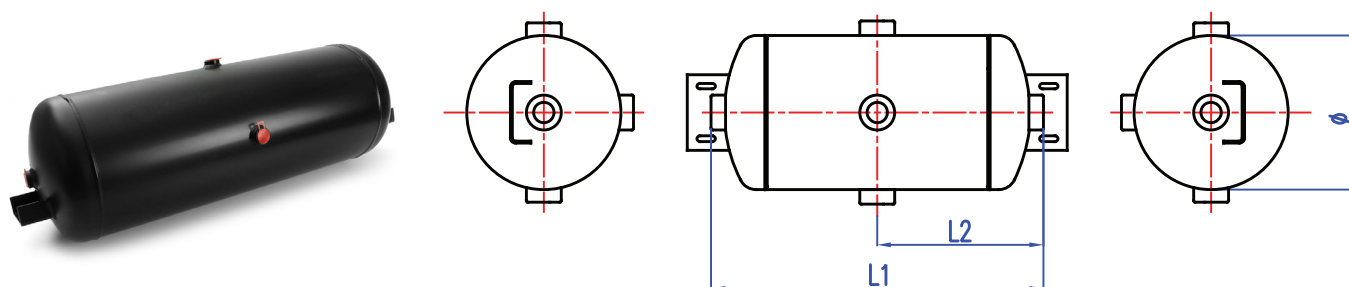
AIR TANK

HAVA TANKI







OEM / COMPARISON NO		LITER LİTRE	∅	↔ L1 / L2			TYPE / TİP
SPA179M	12,5 bar	38	246 mm	839 / 420 mm	15 kg	M22x1,5	

99318AP

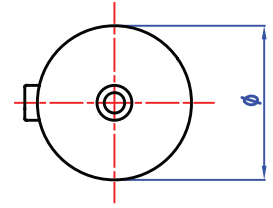
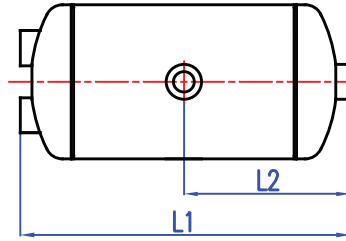
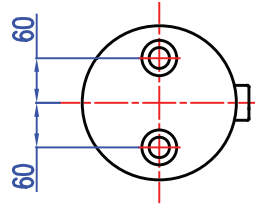
AIR TANK

HAVA TANKI







OEM / COMPARISON NO		LITER LİTRE	Ø	↔ L1 / L2			TYPE / TİP
SPA1016	10 bar	120	396 mm	1067 / 538 mm	34,3 kg	M22x1,5	

99321AP

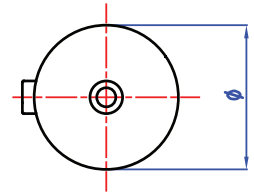
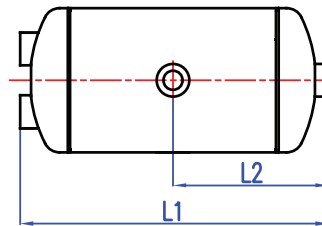
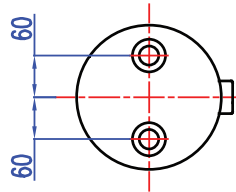
AIR TANK

HAVA TANKI







OEM / COMPARISON NO		LITER LİTRE	Ø	↔ L1 / L2			TYPE / TİP
X1021	16 bar	39	310 mm	600 / 305 mm	13,3 kg	M22x1,5	

99322AP

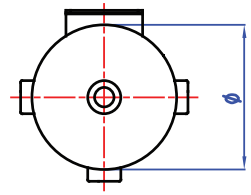
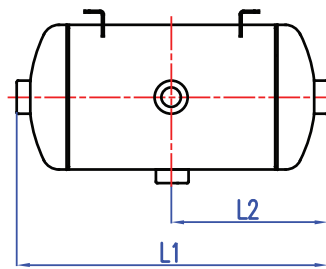
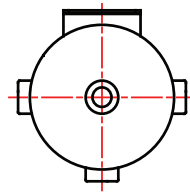
AIR TANK

HAVA TANKI







OEM / COMPARISON NO		LITER LİTRE	Ø	↔ L1 / L2			TYPE / TİP
X1027	12,5 bar	60	300 mm	888 / 444 mm	18,8 kg	M22x1,5	

99323AP

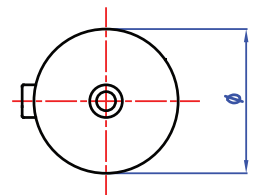
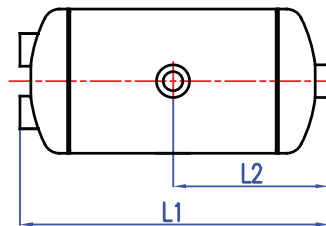
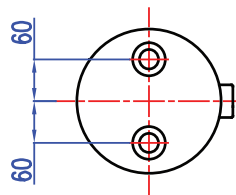
AIR TANK

HAVA TANKI







OEM / COMPARISON NO		LITER LİTRE	Ø	↔ L1 / L2			TYPE / TİP
X1022	12,5 bar	80	380 mm	794 / 402 mm	21 kg	M22x1,5	

99324AP

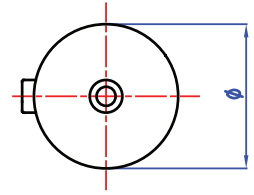
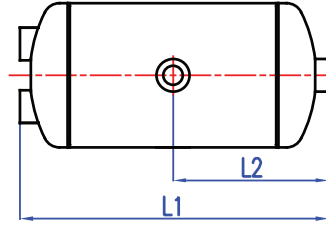
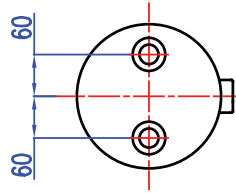
AIR TANK

HAVA TANKI







OEM / COMPARISON NO		LITER LİTRE	Ø	↔ L1 / L2			TYPE / TİP
X1023	12,5 bar	60	380 mm	614 / 312 mm	16,8 kg	M22x1,5	

99325AP

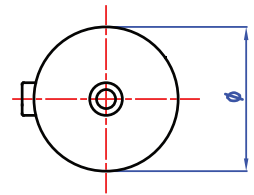
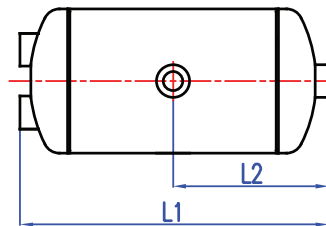
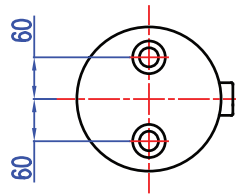
AIR TANK

HAVA TANKI







OEM / COMPARISON NO		LITER LİTRE	Ø	↔ L1 / L2			TYPE / TİP
X1024	12,5 bar	60	320 mm	823 / 416 mm	18,1 kg	M22x1,5	

99326AP

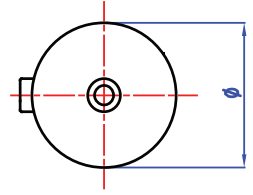
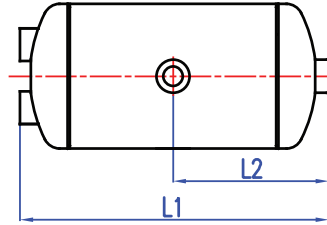
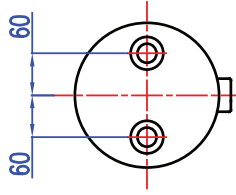
AIR TANK

HAVA TANKI







OEM / COMPARISON NO		LITER LITRE	Ø	↔ L1 / L2			TYPE / TIP
X1025	12,5 bar	30	255 mm	650 / 330 mm	12,1 kg	M22x1,5	

99327AP

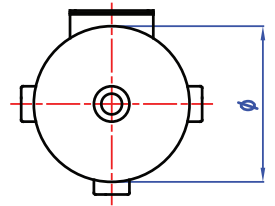
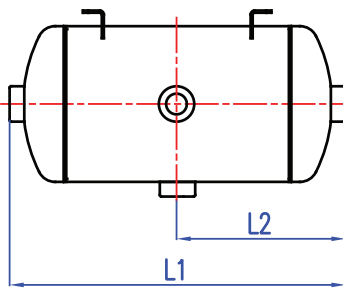
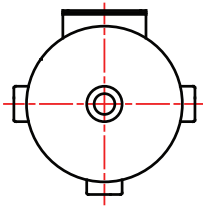



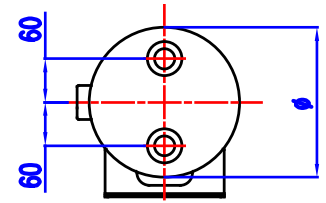
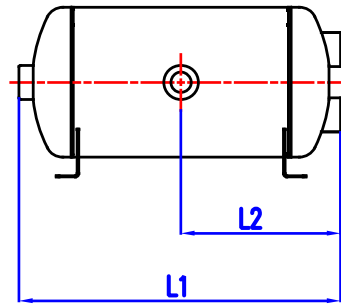
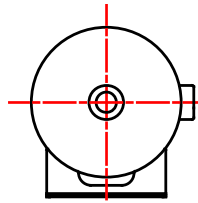

AIR TANK

HAVA TANKI



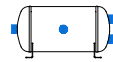

OEM / COMPARISON NO		LITER LITRE	Ø	↔ L1 / L2			TYPE / TIP
X1026	12,5 bar	80	310 mm	1179 / 590 mm	24,7 kg	M22x1,5	





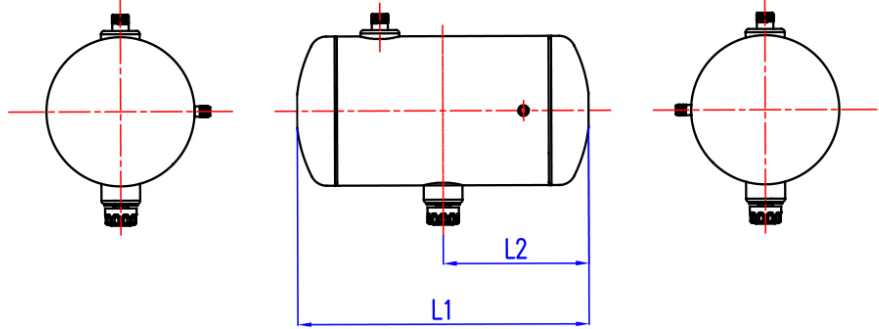

99334AP**AIR TANK****HAVA TANKI**

OEM / COMPARISON NO		LITER LITRE	Ø	↔ L1 / L2			TYPE / TİP
X1107	12,5 bar	60	380 mm	610 / 310 mm	18,8 kg	M22x1,5	  





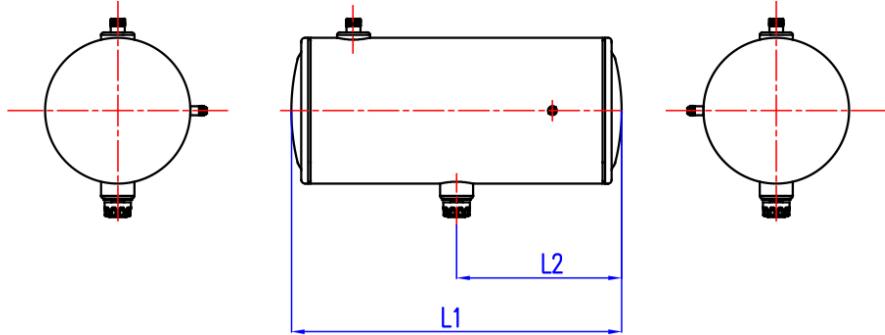

99335AP**AIR TANK****HAVA TANKI**

OEM / COMPARISON NO		LITER LITRE	Ø	↔ L1 / L2			TYPE / TİP
X1108	12,5 bar	80	380 mm	790 / 310 mm	18,8 kg	M22x1,5	

99336AP**AIR TANK****YAĞ TANKI**

OEM / COMPARISON NO		LITER LİTRE	Ø	↔ L1 / L2			TYPE / TİP
X1168		150	380 mm	1417 / 310 mm	18,8 kg	M22x1,5	  

99337AP**AIR TANK****YAĞ TANKI**



OEM / COMPARISON NO		LITER LİTRE	Ø	↔ L1 / L2			TYPE / TİP
X1169		180	440 mm	1315 / 310 mm	18,8 kg	M22x1,5	  

99342AP

AIR TANK

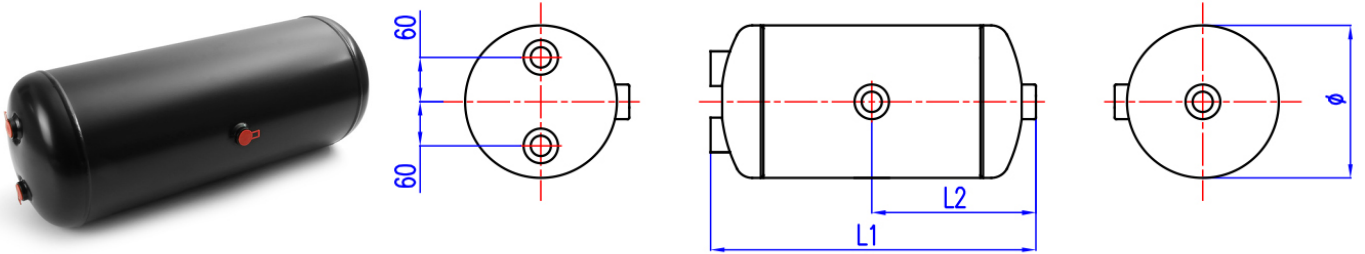
HAVA TANKI



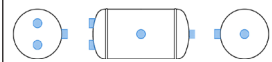



OEM / COMPARISON NO		LITER LITRE	Ø	↔ L1 / L2			TYPE / TİP
X1177	12,5 bar	40	276 mm	760 / 110 mm	5,3 kg	M22x1,5	

99348AP

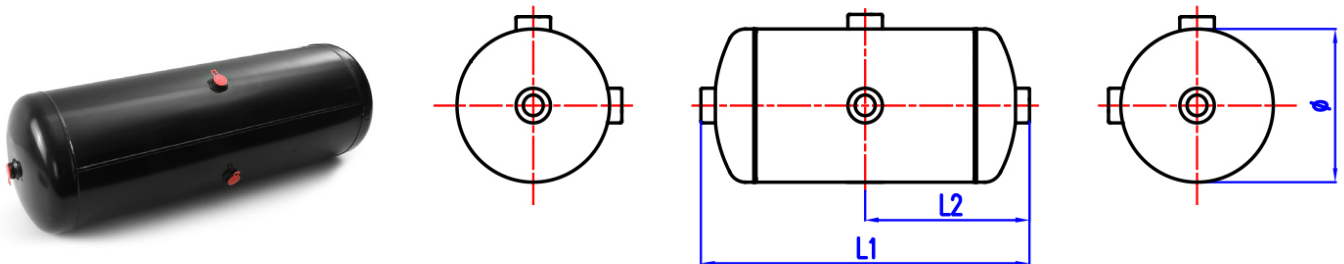



AIR TANK

HAVA TANKI

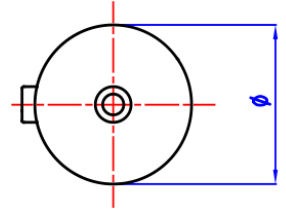
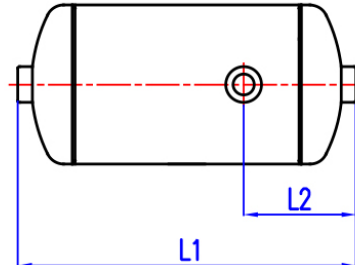
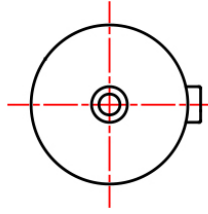



OEM / COMPARISON NO		LITER LITRE	Ø	↔ L1 / L2			TYPE / TİP
X1324	10 bar	60	320 mm	873 / 437 mm	18,9 kg	M22x1,5	

99362AP**AIR TANK****HAVA TANKI**

OEM / COMPARISON NO		LITER LITRE	Ø	↔ L1 / L2			TYPE / TİP
81514010147	12,5 bar	10	246 mm	274 / 110 mm	5,3 kg	M22x1,5	

99370AP**AIR TANK****HAVA TANKI**

OEM / COMPARISON NO		LITER LITRE	Ø	↔ L1 / L2			TYPE / TİP
X1324	12,5 bar	20	246 mm	274 / 310 mm	18,8 kg	M22x1,5	

99328AP

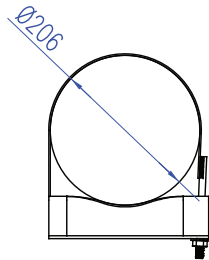

99329AP

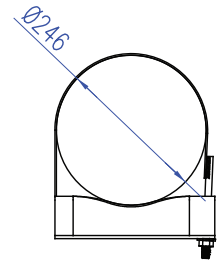

99330AP

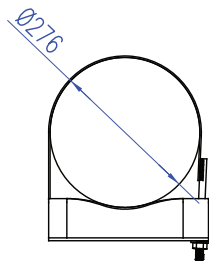

99331AP

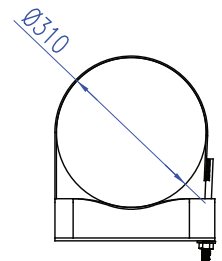

99332AP

